

DSC-T10

Ver. 1.1 2007.08

Revision History

SECTION 6 ADJUSTMENTS

Auto-ADJ

Link

• Before starting adjustments

• Adjusting items when replacing main parts and boards

• List of service tools

• SERVICE MODE

• SERVICE MODE

• CAMERA SECTION ADJUSTMENTS

• PREPARATIONS BEFORE ADJUSTMENTS

• ADJUSTMENT PROGRAMS

• VIDEO SYSTEM ADJUSTMENTS

• CAMERA SYSTEM ADJUSTMENTS

• LCD SYSTEM ADJUSTMENTS

• ERROR

• INITIALIZATION OF DATA

- Use this Service Manual together with the Automatic Adjustment Program (DSC-T10 Auto-Adj Ver_1.1r02.exe) and the AWB Adjustment Program (T10AwbAdjustment.exe).
- [Precaution on Replacing the SY-163 Board](#)

SONY®

TABLE OF CONTENTS

<u>Section</u>	<u>Title</u>	<u>Page</u>
6.	ADJUSTMENTS	
	Before Starting Adjustments	6-1
1-1.	Adjusting Items When Replacing	
	Main Parts and Boards	6-5
1-2.	List of Service Tools	6-6
6-1.	Camera Section Adjustments	6-7
1-1.	Preparations Before Adjustments	6-7
1-2.	Adjustment Programs	6-11
1-3.	Video System Adjustments	6-13
1-4.	Camera System Adjustments	6-15
1-5.	LCD System Adjustments	6-27
1-6.	Error	6-29
1-7.	Initialization of Data	6-31
6-2.	Service Mode	6-32

SECTION 6 ADJUSTMENTS

Before starting adjustments

Precaution on Replacing the SY-163 Board

- The Repair Board has already been adjusted. Re-initialization or EVR data copy from the set before repair is not required.
- Perform “VIDEO OUT Default Data Check” and “INITIAL LANGUAGE Default Data Check” mentioned below, and also the adjustment items necessary after SY Board replacement.

VIDEO OUT Default Data Check

If the SY-163 board is replaced, the broadcast system data setting (NTSC/PAL) might be changed. Check the default data of VIDEO OUT if destination code is right. If not, rewrite to the right value.

VIDEO OUT Default Data

Page	Address	Data	
		NTSC	PAL
4F	8D	00	01

Writing Method:

- 1) Select page: 00, address: 01, and set data: 01.
- 2) Select page: 4F, address: 8D, and set data: 00 (NTSC) or data: 01 (PAL).
- 3) Select page: 40, address: 38, and set data: 00.
- 4) Click **Save** on the SEUS screen.
- 5) Select page: 80, address: 34, and check that the data is “00”.
- 6) Select page: 80, address: 30, and check that the data is “00”.
- 7) Select page: 00, address: 01, and set data: 00.

INITIAL LANGUAGE Default Data Check

If the SY-163 board is replaced, initial language setting may be changed. Check the default data of INITIAL LANGUAGE if destination code is right. If not, rewrite to the right value.

Initial language: Language displayed at the next starting if the setting of Setup menu was reset.
It is different from the language setting selectable with the menu.

Initial Language Data

Page	Address	Data	Language	GP1	GP2	GP3	GP4
4F	8C	00	English		●	●	●
		01	Japanese	●			
		04	Spanish			●	●
		06	Portugal				●
		08	Simplified Chinese				●
		0B	Russian			●	
		0D	Korean				●

GP1 is fixed to Japanese.

GP2 is fixed to English.

GP3 is either English, Spanish, or Russian.

GP4 is either English, Spanish, Portugal, Simplified Chinese, or Korean.

Writing Method:

- 1) Select page: 00, address: 01 and set data: 01.
- 2) Select page: 4F, address: 8C, and set the Initial Language Data.
- 3) Select page: 40, address: 38, and set data: 00.
- 4) Click **[Save]** on the SEUS screen.
- 5) Select page: 80, address: 34, and check that the data is "00".
- 6) Select page: 80, address: 30, and check that the data is "00".
- 7) Select page: 00, address: 01, and set data: 00.
- 8) Turn off the camera.
- 9) Turn on the camera. Execute "Initialize" of Setup screen.
- 10) Check the language displayed when the camera starts.

Method for Copying or Erasing the Data in Internal Memory (Internal Memory/Music)

The data can be copied/erased by the operations on the Setup screen. (When erasing the data, execute formatting the internal memory.)

Note 1: When replacing the SY-163 board, erase the data in internal memory of the board before replacement.

Note 2: When replacing the SY-163 board or the IC401 on the SY-163 board, execute formatting and initialize the internal memory after replacement.

Method for copying the data in internal memory

Copy

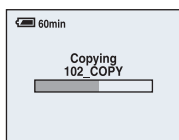

Copies all images in the internal memory to a "Memory Stick Duo".

- ① Insert a "Memory Stick Duo" having 64 MB or larger capacity.
- ② Select [OK] with ▲ on the control button, then press ●.
The message "All data in internal memory will be copied Ready?" appears.
- ③ Select [OK] with ▲, then press ●.
Copying starts.



To cancel the copying

Select [Cancel] in step ② or ③, then press ●.

- Use a fully charged battery pack or the AC Adaptor (not supplied). If you attempt to copy image files using a battery pack with little remaining charge, the battery pack may run out, causing copying to fail or possibly corrupting the data.
- You cannot copy individual images.
- The original images in the internal memory are retained even after copying. To delete the contents of the internal memory, remove the "Memory Stick Duo" after copying, then execute the [Format] command in  (Internal Memory Tool).
- You cannot select a folder copied on a "Memory Stick Duo".
- Even if you copy data, a  (Print order) mark is not copied.

Method for formatting the internal memory

This item does not appear when a "Memory Stick Duo" is inserted in the camera.

Format

Formats the internal memory.

- Note that formatting irrevocably erases all data in the internal memory, including even protected images.

- ① Select [OK] with ▲ on the control button, then press ●.
The message "All data in internal memory will be erased Ready?" appears.
- ② Select [OK] with ▲, then press ●.
The format is complete.

To cancel the formatting

Select [Cancel] in step ① or ②, then press ●.

Method for formatting the Music

Format Music

If you cannot play back a Music file for the Slide Show, the Music file might be corrupted. If this happens, perform [Format Music].

When [Format Music] is performed, all the Music files are erased. Use the supplied software "Music Transfer" to activate [Download Music].

- ① Select [OK] with ▲ on the control button, then press ●.
The message "All data will be erased Ready?" appears.
- ② Select [OK] with ▲, then press ●.
All the Music files are erased.

To cancel the formatting

Select [Cancel] in step ① or ②, then press ●.

1-1. Adjusting items when replacing main parts and boards

When replacing main parts and boards, adjust the items indicated by ● in the following table.

Note 1: The automatic Adjustment Program does not support the “Initialization of data” and “Wide Limit Adjustment”. Perform them manually.

Note 2: Use the AWB Adjustment Program (T10AwbAdjustment.exe).

Note 3: When replacing the SY-163 board, erase the data in internal memory of the board before replacement.

Note 4: When replacing the SY-163 board or the IC401 on the SY-163 board, execute formatting and initialize the internal memory after replacement.

Note 5: When replacing the SY-163 board, perform “VIDEO OUT Default Data Check” and “Initial Language Data Check” after replacement.

Adjusting item	Adjustment	Replaced parts												
		Block replacement				Mounted parts replacement				Board replacement				
		Lens block	CCD block assy (Including CD-656 flexible board and CCD imager)	Flash unit	LCD block	LCD block	ST-131 board	SY-163 board	SY-163 board	SY-163 board	SY-163 board	ST-131 board	SY-163 board	
VIDEO adjustment	Video output level adj.							●	●					●
CAMERA adjustment 1	Hall adj.	●												●
(Note 1)	Wide limit adj.	●												●
CAMERA adjustment 2	Flange back adj.	●	●											●
CAMERA adjustment 3	Flange back check	●	●											●
CAMERA adjustment 4	F No. compensation													
	Measure gain adj.	●	●				●							●
	Mechanical shutter adj.													
	Light value adj.													
(Note 2)	AWB 3200K-5800K standard data input		●				●							●
CAMERA adjustment 5	Color reproduction adj. & check													
	CCD linearity check		●					●						●
	CCD white defect compensation check													
	CCD black defect compensation check													
CAMERA adjustment 6	Strobe adj.		●	●				●					●	●
CAMERA adjustment 7	Auto focus illumination check						●						●	●
CAMERA adjustment 8	Angular velocity sensor sensitivity adj.	●										●		●
LCD adjustment	V-COM adj.				●	●			●					●
	White Balance adj.													
(Note 1)	Initialization of data													

1-2. List of service tools

- Oscilloscope
- Color monitor

<p>J-1</p>  <p>Personal computer (Note 1)</p>	<p>J-2</p>  <p>HASP key and application for adjustment (SEUS)</p> <p>Contact our service headquarter of each area how to get the application for adjustment (SEUS) and HASP key.</p>	<p>J-3</p>  <p>USB, A/V, DC IN cable for multi-use terminal 1-830-848-11</p>
<p>J-4</p>  <p>Pattern box PTB-450 J-6082-200-A or Small pattern box PTB-1450 J-6082-557-A</p>	<p>J-5</p>  <p>9 colors chart (Note 2)</p> <p>For PTB-1450: J-6082-562-A</p>	<p>J-6</p>  <p>Clear chart</p> <p>For PTB-450: J-6080-621-A</p> <p>For PTB-1450: J-6082-560-A</p>
<p>J-7</p>  <p>Minipattern box J-6082-353-B</p>	<p>J-8</p>  <p>Flange back adjustment jig J-6082-563-A</p>	<p>J-9</p>  <p>Siemens star chart J-6080-875-A</p>
<p>J-10</p>  <p>Back ground paper J-2501-130-A</p>	<p>J-11</p>  <p>AC power adaptor AC-LS5 1-479-284-51</p>	

Fig. 6-1-1

Note 1: Personal computer

- OS: Windows98/98SE/Me/2000/XP Home/XP Pro
 - RAM: 256MB or more recommended
 - USB: 2.0 recommended (also compatible with 1.1)
- Two connectors are required.

Note 2: In using the 9 colors chart on the pattern box PTB-450, adjust the chart size through the procedure shown below so that it matches to the pattern box PTB-450.

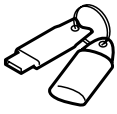
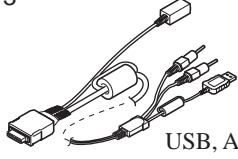
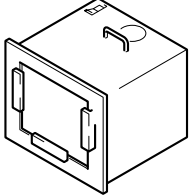
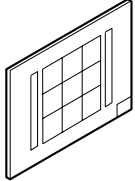
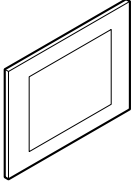
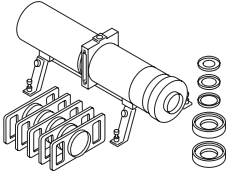
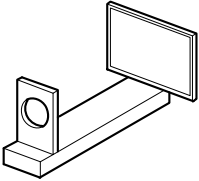
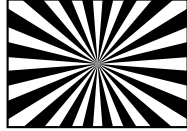
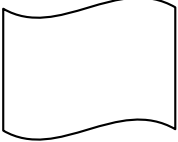
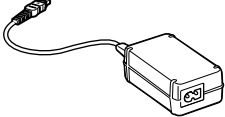
- 1) Prepare a woody board A of the thickness 5 mm, and paint it mat-black.
- 2) Fit the 9 colors chart in the woody board A, and secure the chart with a black tape, etc. to shield the light.

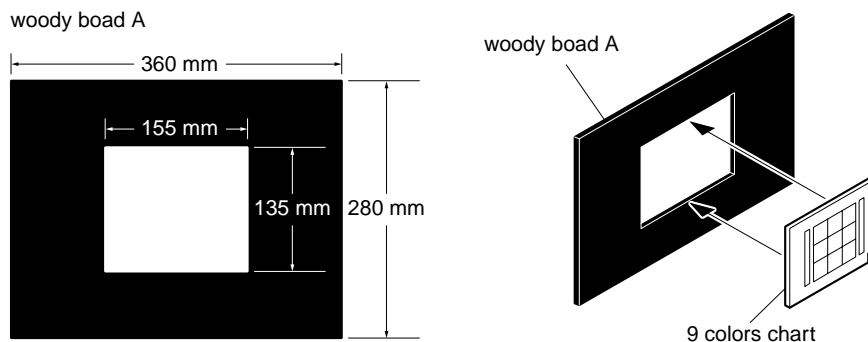

Fig. 6-1-2

6-1. CAMERA SECTION ADJUSTMENTS

1-1. PREPARATIONS BEFORE ADJUSTMENTS

1-1-1. Preparations

- 1) Connect the equipment for adjustments according to Fig. 6-1-4.
- 2) Start up the application for adjustment (SEUS).

Note: Before perform the adjustment, set the following data.

- 1) Select page: 40, address: 38 and set data: 00.

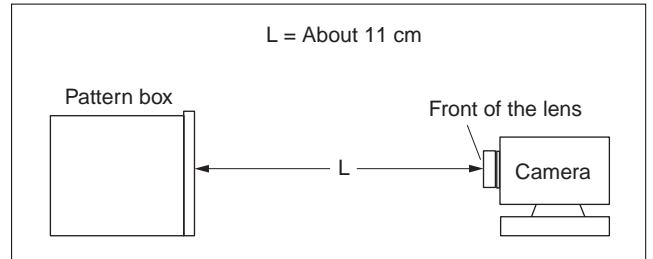

Fig. 6-1-3

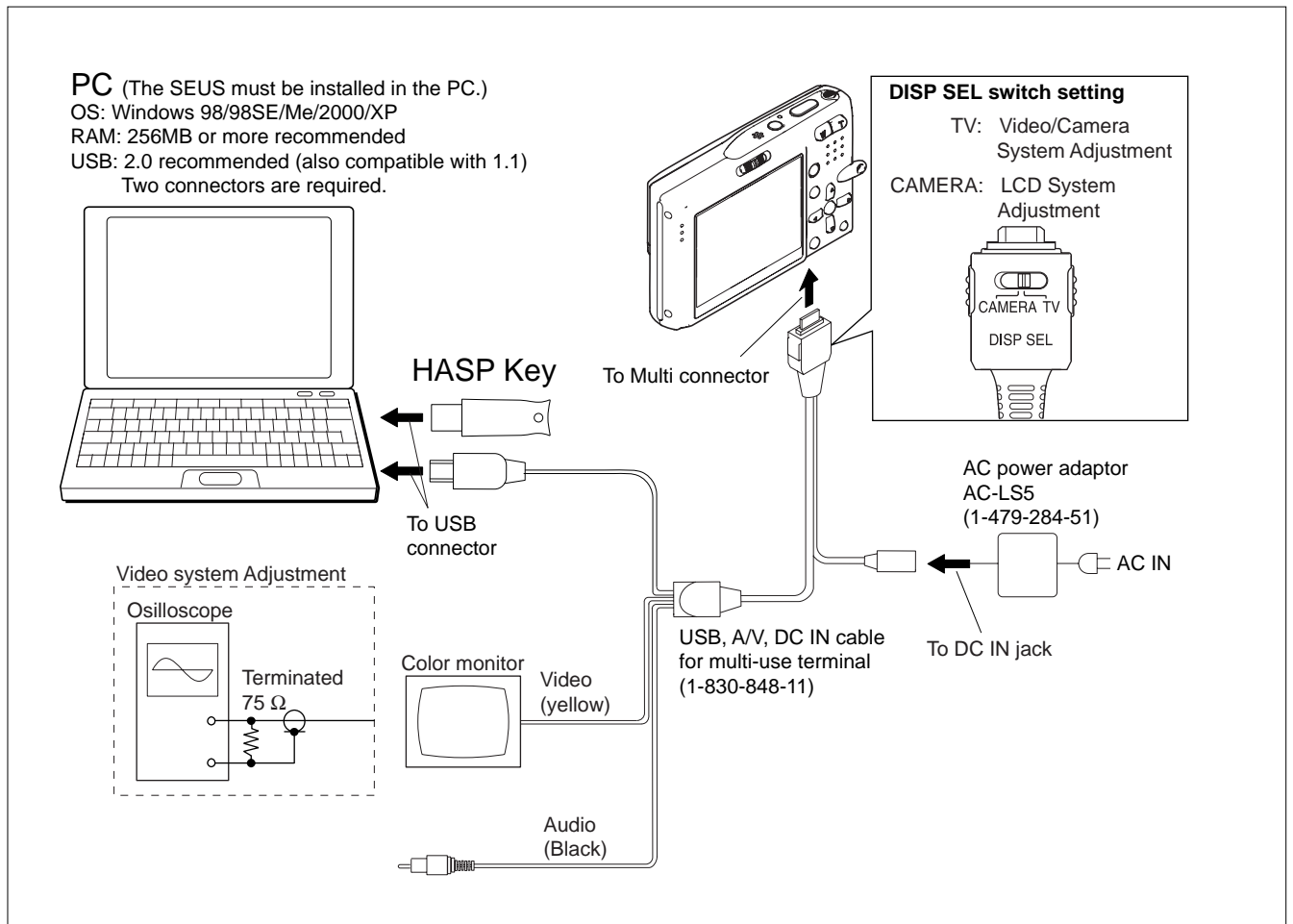

Fig. 6-1-4

1-1-2. Precautions

1. Setting the Switch

Unless otherwise specified, set the switches as follows and perform adjustments.

1. Mode switch CAMERA
2. ZOOM button WIDE end
3. Digital Zoom (SET UP setting) Off
4. Camera (Menu items) Auto

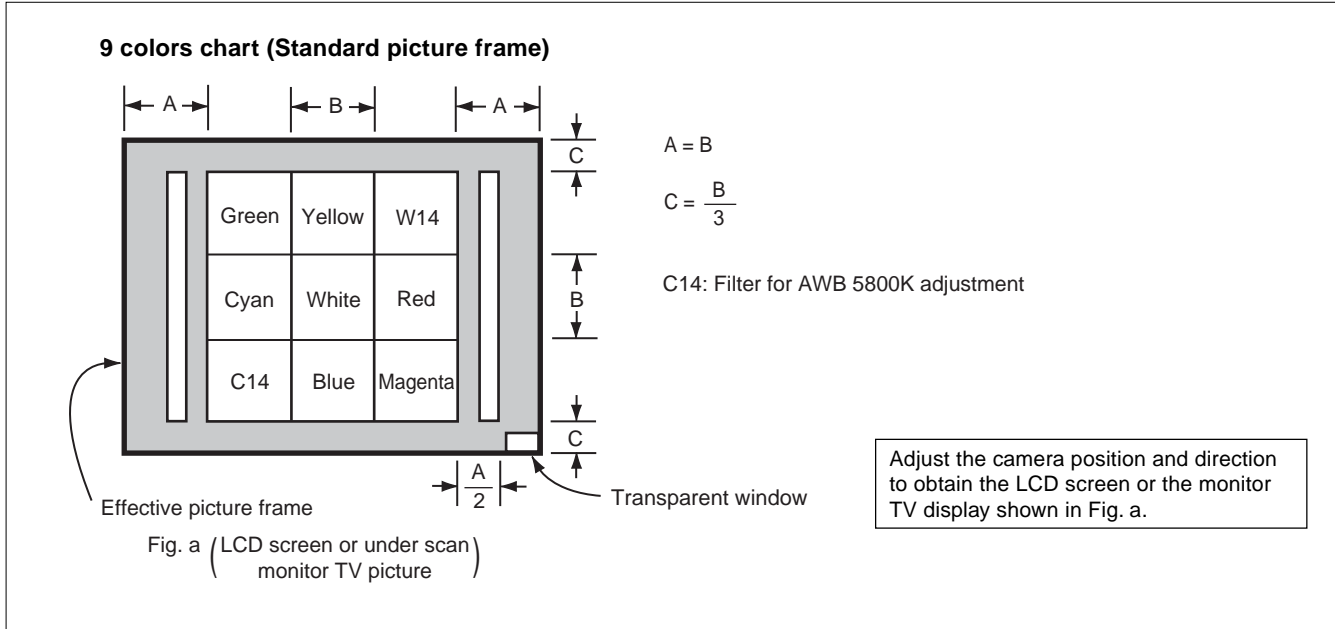

Fig. 6-1-5

2. Subjects

- 1) 9 colors chart (Standard picture frame).
When performing adjustments using the 9 colors chart, adjust the picture frame as shown in Fig. 6-1-5. (Standard picture frame)
- 2) Clear chart (Standard picture frame)
Remove the 9 colors chart from the pattern box and insert a clear chart in its place. (Do not perform zoom operations during this time)

3. Preparing the Flash Adjustment Box

A dark room is required to provide an accurate flash adjustment. If it is not available, prepare the flash adjustment box as given below;

- 1) Provide woody board A, B and C of 15 mm thickness.

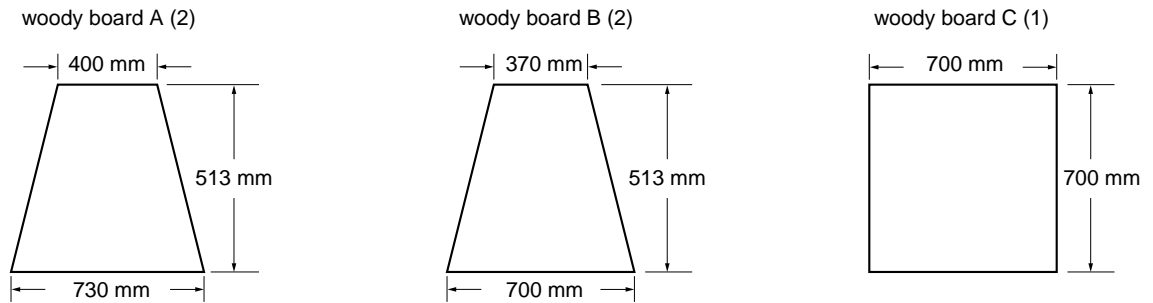

Fig. 6-1-6

- 2) Apply black mat paint to one side of woody board A and B.
- 3) Attach background paper (J-2501-130-A) to woody board C.
- 4) Assemble so that the black sides and the background paper side of woody board A, B and C are internal. (Fig. 6-1-7)

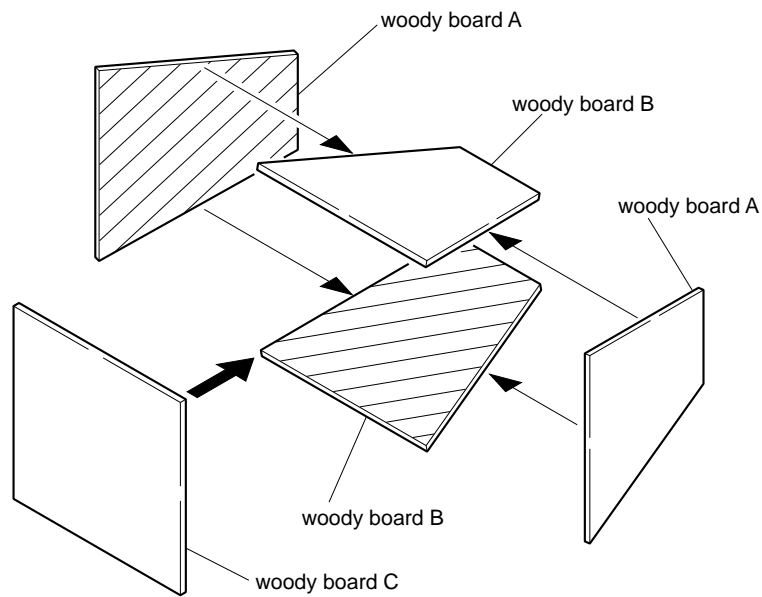

Fig. 6-1-7

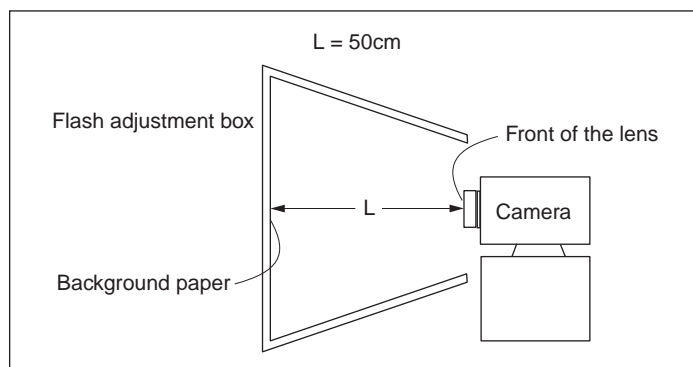

Fig. 6-1-8

1-1-3. Using Method of SEUS

The application for adjustment (SEUS) is used to change the coefficient for calculating the signal processing or EVR data. The SEUS performs two-way communication between PC and set through the USB terminal. The two-way communication result data can be written to the nonvolatile memory.

1. Connection

- 1) Connect the HASP key to the USB terminal of the PC.
- 2) Connect the PC and set with the USB cable.
- 3) Confirm that the set starts in the USB mode.
- 4) Start the SEUS on the PC.
- 5) Click **[Connect]** on the SEUS screen. If the connection is normal, the SEUS screen will be as shown in Fig. 6-1-9, indicating the "connected" state.

Note: The SEUS will go in "disconnect" state, if the set is turned off (for instance, by resetting the set). In such a case, click **[Connect]** on the SEUS screen to restore the "connected" state.

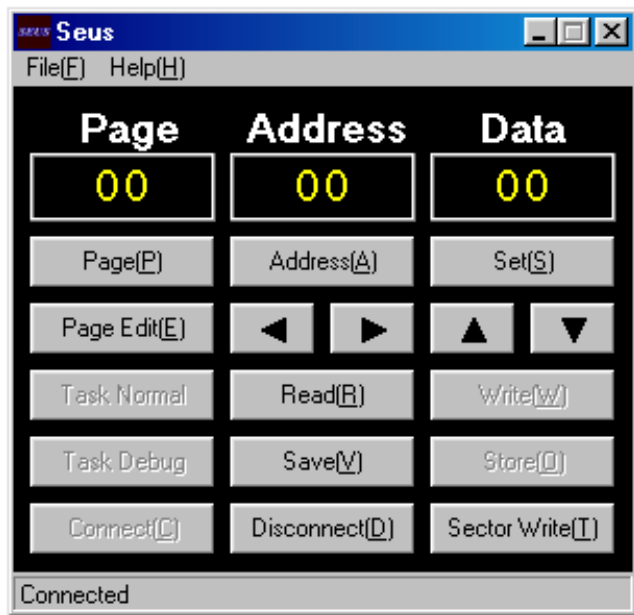

Fig. 6-1-9

2. Operation

- Page change
To change the page, click **[Page]** on the SEUS screen and enter the page to be changed. The page is displayed in hexadecimal notation.
- Address change
To change the address, click **[Address]** on the SEUS screen and enter the address to be changed. The address is displayed in hexadecimal notation.
- Data change
To change the data, click **[Set]** on the SEUS screen and enter the data. The data is displayed in hexadecimal notation. This operation does not write the data to the nonvolatile memory.
- Data saving
To write the all changed data to the nonvolatile memory, click **[Save]** on the SEUS screen and wait for more than 3 sec.
- Data reading
The data displayed on the SEUS screen are the data values at the time when the pages and addresses were set, and they are not updated automatically. To check the data change, click **[Read]** on the SEUS screen and update the displayed data.

1-1-4. Precaution on Use of SEUS

Wrong SEUS operation could clear correct adjustment data. To prevent the data clear by mistake, it is recommended to save all adjustment data by clicking **[Page Edit]** on the SEUS screen before starting the adjustment.

Saving Method:

- 1) Click **[Page Edit]** on the SEUS screen to display the SEUS PAGE EDIT screen.
- 2) Click **[Page]**, and enter the page number to be saved.
- 3) Click **[Read]** to read the data to be saved from the camera.
- 4) Click **[File]** and save the data to PC.

Loading Method:

- 1) Select page: 00, address: 01 and set data: 01.
- 2) Click **[Page Edit]** on the SEUS screen to display the SEUS PAGE EDIT screen.
- 3) Click **[File]** and load the data from PC.
- 4) Click **[Write]** on the SEUS PAGE EDIT screen.
- 5) Click **[Close]** to close the SEUS PAGE EDIT screen.
- 6) Select page: 40, address: 38 and set data: 00.
- 7) Click **[Save]** on the SEUS screen.
- 8) Select page: 80, address: 34, and check that the data is "00".
- 9) Select page: 80, address: 30, and check that the data is "00".
- 10) Select page: 00, address: 01 and set data: 00.

1-2. ADJUSTMENT PROGRAMS

The DSC-T10 is adjusted with the Automatic Adjustment Program and the AWB Adjustment Program.

The Automatic Adjustment Program automatically controls the adjustment operations that were formerly entered manually on the operation screen of the SEUS (some adjustments may be manually operated on the SEUS operation screen).

The AWB Adjustment Program automatically performs “AWB 3200K-5800K Standard Data Input” of Camera System Adjustment.

1-2-1. Automatic Adjustment Program

1. Precautions When Using Automatic Adjustment Program

- 1) The Automatic Adjustment Program writes the adjustment results such as EVR data to the set through two-way communication with the camera via the SEUS. Accordingly, the Automatic Adjustment Program must be used in the environment where the SEUS operates.
- 2) The program run time may vary depending on the environment of the personal computer used.
- 3) The SEUS must be already started on the PC when using the Automatic Adjustment Program. With the SEUS not started, some adjustment items will take time in adjustment.

2. Start of Automatic Adjustment Program

Double-click the application file (DSC-T10 Auto-Adj Ver_1.□r□□.exe), and the Automatic Adjustment Program will start.

Note: □ (numeric value) of the file name varies depending on the version of Automatic Adjustment Program.

3. Function of Each Button on Main Menu Screen

When the Automatic Adjustment Program started, the Main Menu screen in Fig. 6-1-10 will appear. On this screen, select each adjustment section.

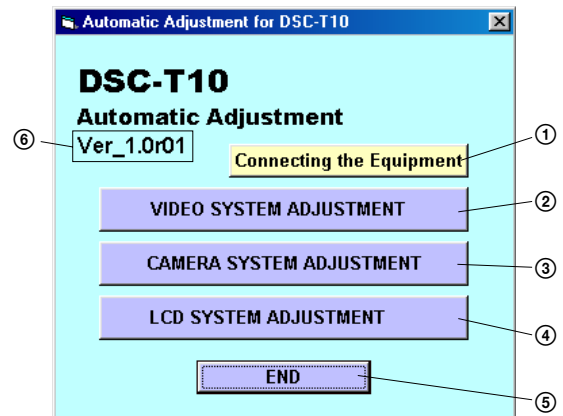

Fig. 6-1-10

- ① **Connecting the Equipment** button
A connection diagram of the equipment is displayed.
- ② **VIDEO SYSTEM ADJUSTMENT** button
The “VIDEO SYSTEM ADJUSTMENT” screen appears.
- ③ **CAMERA SYSTEM ADJUSTMENT** button
The “CAMERA SYSTEM ADJUSTMENT” screen appears.
- ④ **LCD SYSTEM ADJUSTMENT** button
The “LCD SYSTEM ADJUSTMENT” screen appears.
- ⑤ **END** button
The Automatic Adjustment Program finishes.
- ⑥ This part indicates the version of Automatic Adjustment Program.

1-2-2. AWB Adjustment Program

1. Application Environment

OS: Windows 98/98SE/Me/2000/XP

RAM: 256MB or more recommended

USB: 2.0 recommended (also compatible with 1.1)

Two connectors are required.

2. Installation Method

Extract the file compressed in the ZIP format (T10AWB Adjustment.zip). Execute the extracted file (setup.exe), and the installer will start. Install the program following the instructions given on the installer screen.

3. Notes When Using the AWB Adjustment Program

- 1) The SEUS must be installed in the PC.
- 2) The HASP Key for SEUS must be connected to the USB connector. The program will not start unless the HASP Key is connected.

4. Starting Method of AWB Adjustment Program

Click the **[Start]** button on the task bar, and click the **[DSC-T10 AWB Adjustment]** from the **[Programs]**, and the program will start.

5. Screen and Function of Each Button of AWB Adjustment Program

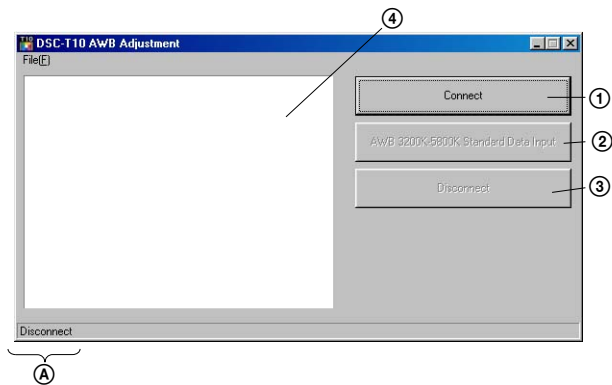

Fig. 6-1-11

- ① **[Connect]** button
Makes connection to the camera and switches the camera to the adjustment mode. In the case of successful connection to the camera, the indication at the part (A) changes to “Connected” and the following buttons become active.
 - **[AWB 3200K-5800K Standard Data Input]** button
 - **[Disconnect]** button
- ② Adjustment start buttons
Start the adjustment or checking of respective button names.
- ③ **[Disconnect]** button
Cancels the connection to the camera.
- ④ Captured picture display screen
Displays a picture captured by the camera when the adjustment or checking was performed.

1-3. VIDEO SYSTEM ADJUSTMENTS

1-3-1. Function of Each Button on Video System Adjustment Screen

Click the **VIDEO SYSTEM ADJUSTMENT** button on the Main Menu screen, and the “VIDEO SYSTEM ADJUSTMENT” screen in Fig. 6-1-12 will appear.

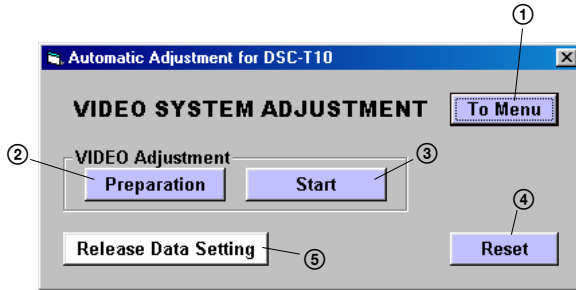

Fig. 6-1-12

- ① **To Menu** button
The Main Menu screen comes back.
- ② **Preparation** button
Notes for adjustment or jigs used are displayed.
- ③ **Start** button
“Video Adjustment” starts.
- ④ **Reset** button
This button functions same as the “Initialize” of the setup screen.
- ⑤ **Release Data Setting** button
The data setting at the adjustment is cancelled.
During the data setting, the button color changes from “white” to “red”. When the data setting is cancelled, the button color returns to “white”.
(Use this button when an error occurred in the video adjustment. If the adjustment completed successfully, the data setting is automatically cancelled and the button color returns to “white”.)

1-3-2. Adjustment Items of VIDEO System Adjustment

The adjustment items of video system adjustment are as listed in Table 6-1-2. The Automatic Adjustment Program executes the adjustment items if the VIDEO Adjustment Start button is clicked.

Button Name	Adjustment	Signal	Page	Address
VIDEO Adjustment	VIDEO Output Level Adj.	Arbitrary	8F	D0

Table 6-1-2

1-3-3. Adjusting Method

[Automatic Adjustment Program execution items and sequence]

1. Data Setting during Video Adj.
2. Video Output Level Adj.
3. Release of Data Setting during Video Adj.

[Specified value of video output level adj.]

Measurement Point	Video terminal of USB, A/V, DC IN cable for multi-use terminal (75 Ω terminated)
Measuring Instrument	Oscilloscope
Specified Value	Sync level: A = 286 ± 5 mV (NTSC mode) A = 300 ± 5 mV (PAL mode) Burst level: B = 286 ± 25 mV (NTSC mode) B = 300 ± 25 mV (PAL mode)

[Adjusting method]

- 1) Click the **[Start]** button of the VIDEO Adjustment.
- 2) The Automatic Adjustment Program executes the “1. Data Setting during Video Adj.”
- 3) If “1. Data Setting during Video Adj.” completed successfully, the next message is displayed during the execution of “2. Video Output Level Adj.”. Using the UP/DOWN key on the SEUS Operation screen, adjust so that the sync level of the video signals satisfies the specified value. After the adjustment, check that the burst level of the video signals satisfies the specified value, and click the **[OK]** button in the message.

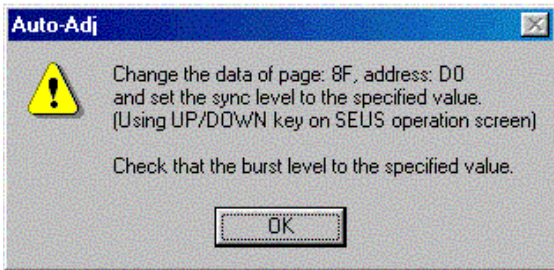

Fig. 6-1-13

- 4) If the **[OK]** button is clicked, “3. Release of Data Setting during Video Adj.” will be executed.
- 5) Upon successful completion of all items of the VIDEO Adjustment, the following message is displayed. Click the **[OK]** button.

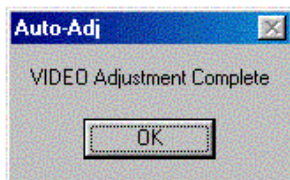

Fig. 6-1-14

SEUS operation screen

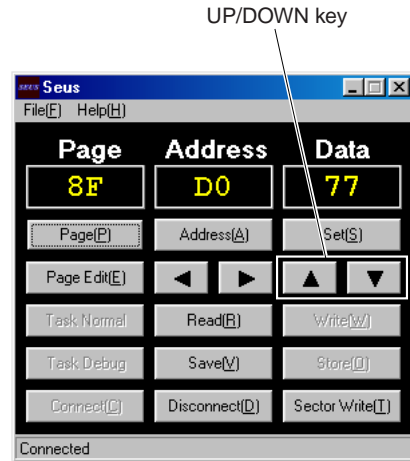

Fig. 6-1-15

Check on the oscilloscope

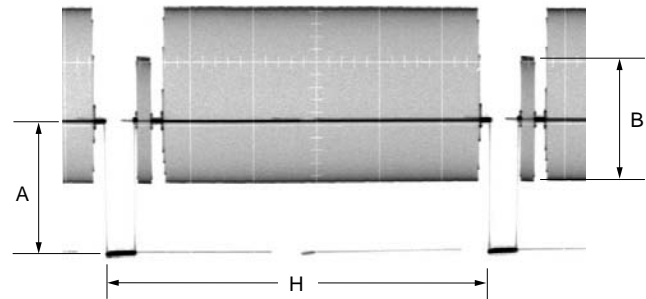

Fig. 6-1-16

1-4. CAMERA SYSTEM ADJUSTMENTS

1-4-1. Function of Each Button on Camera System Adjustment Screen

Click the **CAMERA SYSTEM ADJUSTMENT** button on the Main Menu screen, and the “CAMERA SYSTEM ADJUSTMENT” screen in Fig. 6-1-17 will appear.

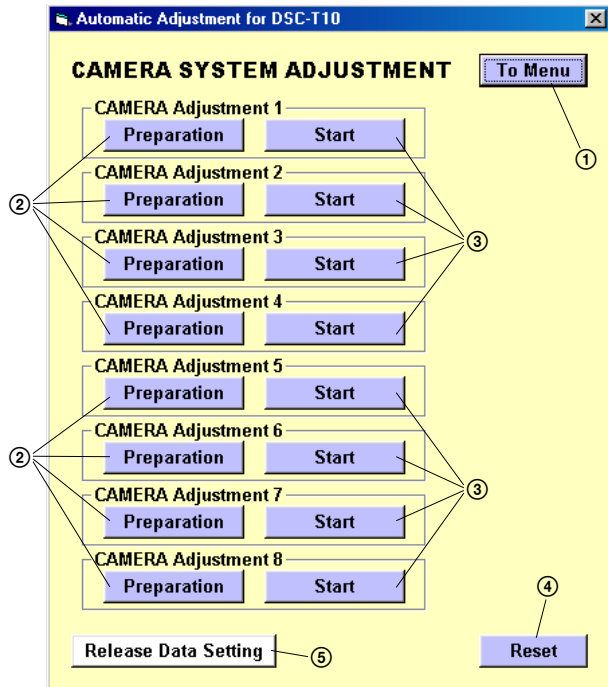

Fig. 6-1-17

- ① **To Menu** button
The Main Menu screen comes back.
- ② **Preparation** button
Notes for adjustment or jigs used are displayed.
- ③ **Start** button
Each adjustment from “Camera Adjustment 1” to “Camera Adjustment 8” starts.
- ④ **Reset** button
This button functions same as the “Initialize” of the setup screen.
- ⑤ **Release Data Setting** button
The data setting at the adjustment is cancelled.
During the data setting, the button color changes from “white” to “red”. When the data setting is cancelled, the button color returns to “white”.
(Use this button when an error occurred in the camera adjustment 1-8. If the adjustment completed successfully, the data setting is automatically cancelled and the button color returns to “white”.)

1-4-2. Adjustment Items of Camera System Adjustment

The adjustment items of camera system adjustment are as listed in Table 6-1-3. The Automatic Adjustment Program divides the adjustment items into eight, camera adjustment 1-8. Clicking either CAMERA Adjustment Start button allows the adjustment item which corresponds to that button to be executed.

The adjustment conditions of the subject and filter vary depending on which item is adjusted. The Adjustment Program displays an instruction for the subject and filter as a message during the adjustment.

Button Name	Adjustment	Subject	Adjustment Page	Adjustment Address
CAMERA Adjustment 1	Hall Adj.	Not required	CE	54 to 57
			CF	12 to 29, B0 to C3,
(Note 1)	Wide Limit Adj.	Not required	6F	18, 19
CAMERA Adjustment 2	Flange Back Adj.	Siemens star chart with ND filter for minipattern box (Note 2) or Flange back adjustment jig	6F	18 to 3F, 52, 53
CAMERA Adjustment 3	Flange Back Check	Siemens star (1.0m from front the lens) (Luminance: 200 to 400 lux)	–	–
CAMERA Adjustment 4	F No. Compensation	Clear chart (Standard picture frame)	6F	60, 61, 6B to 6D
	Measure Gain Adj.		6F	6B, 6F
	Mechanical Shutter Adj.		78	0C to 0F
	Light Value Adj.		6F	6B to 6D, B8 to BD, C7 to C9
(Note 3)	AWB 3200K-5800K Standard Data Input	9 color chart (Standard picture frame)	6E	00 to 21, 24 to 49
CAMERA Adjustment 5	Color Reproduction Adj. & Check	9 color chart (Standard picture frame)	6E	50 to 57
	CCD Linearity Check	Clear chart (Standard picture frame)	–	–
	CCD White Defect Compensation Check		–	–
	CCD Black Defect Compensation Check		–	–
CAMERA Adjustment 6	Strobe Adj.	Flash adjustment box (50 cm)	6E	72 to 75
			6F	D8 to EF
CAMERA Adjustment 7	Auto Focus Illumination Check	Flash adjustment box (50 cm)	6F	10 to 15
CAMERA Adjustment 8	Angular Velocity Sensor Sensitivity Adj.	Not required	CF	0C, 0D

Note 1: The Automatic Adjustment Program does not support the “Wide Limit Adjustment”.

Note 2: Dark Siemens star chart.

Note 3: Use the AWB Adjustment Program (T10AwbAdjustment.exe).

Table 6-1-3

1-4-3. Adjusting Method

1. CAMERA Adjustment 1

[Automatic Adjustment Program execution items and sequence]

1. Data Setting during Camera Adj.
2. Hall Adj.
3. Release of Data Setting during Camera Adj.

[Adjusting method]

- 1) Click the button of CAMERA Adjustment 1.
- 2) The Automatic Adjustment Program executes the "1. Data Setting during Camera Adj."
- 3) Upon successful completion of "1. Data Setting during Camera Adj.", the following screen is displayed.

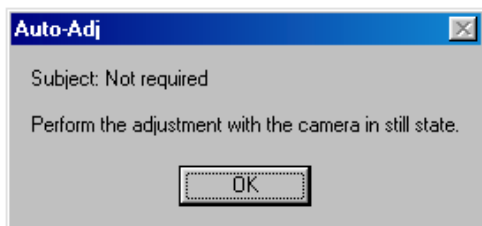

Fig. 6-1-18

- 4) If the button is clicked, "2. Hall Adj." and "3. Release of Data Setting during Camera Adj." will be executed.
- 5) Upon successful completion of all items of the CAMERA Adjustment 1, the following message is displayed. Click the button.

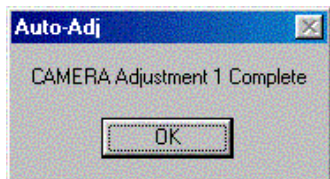

Fig. 6-1-19

2. Wide Limit Adjustment

Adjustment to remove variations at the wide end of the inner focus lens.

Adjustment Page	6F
Adjustment Address	18, 19

2-1. Adjusting method when the lens is replaced:

Adjusting method:

Order	Page	Address	Data	Procedure
1	00	01	01	Set the data.
2	40	38	00	Set the data.
3	6F	18		Set the data. (Note)
4	6F	19		Set the data. (Note)
5	7C	16	01 → 00	Change the data. (The data is OK if it is "00".)
6				Save the data.
7	80	34		Check the data is "00".
8	80	30		Check the data is "00".
9				Perform "Flange Back Adjustment".

Note: The data of page: 6F, address: 18 and 19, that are set in the Orders 3 and 4 as described above, are shown on the data sheet supplied with the replacement lens for repair. Set the upper single byte of the 2-byte data shown on the sheet to address: 18, and the lower byte of the data to the address: 19.

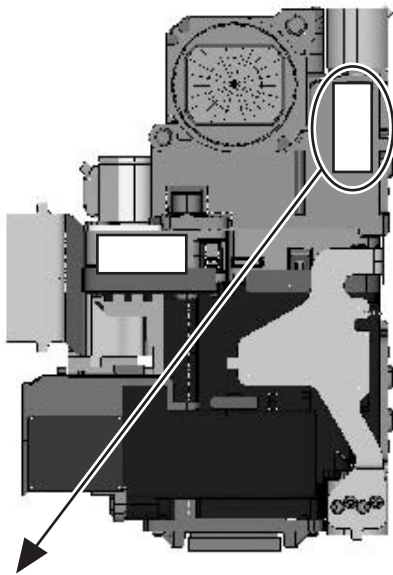

Wide Limit Data (2-byte data)

XXXX

— Data for Page: 6F, Address: 19

— Data for Page: 6F, Address: 18

Fig. 6-1-20

2-2. Adjusting method when replacement of lens is not required and the SY-163 board is replaced:

When the data of page: 6F, address: 18 and 19 can be read from the defective SY-163 board before replacement, and both of the data are not "00":

Adjusting method:

Order	Page	Address	Data	Procedure
1	00	01	01	Set the data.
2	40	38	00	Set the data.
3	6F	18		Set the previous data
4	6F	19		Set the previous data
5	7C	16	01 → 00	Change the data. (The data is OK if it is "00".)
6				Save the data.
7	80	34		Check the data is "00".
8	80	30		Check the data is "00".
9				Perform "Flange Back Adjustment".

When the data of the page: 6F, address: 18 and 19 can be read out from the defective SY-163 board before replacing it, and both of the data are "00":

- 1) Replace the lens with the replacement lens and perform "2-1. Adjusting method when the lens is replaced".

When the data of page: 6F, address: 18 and 19 cannot be read from the defective SY-163 board:

- 1) Replace the lens with the replacement lens and perform "2-1. Adjusting method when the lens is replaced".

Note: The data of page: 7C, address: 16, that is set in the Order 5 of the adjusting method of 2-1 or 2-2, is "01" when shipped from the factory. Let the data remain "00" after completion of the service adjustment.

3. CAMERA Adjustment 2

[Automatic Adjustment Program execution items and sequence]

1. Data Setting during Camera Adj.
2. Flange Back Adj.
3. Release of Data Setting during Camera Adj.

Preparation of Flange Back Adj.

(Using the minipattern box)

- 1) The minipattern box is installed as shown in the following figure.

Note 1: The attachment lenses are not used.

- 2) Install the minipattern box so that the distance between it and the front of lens of camera is less than 3 cm.
- 3) Make the height of minipattern box and the camera equal.
- 4) Check the output voltage of the regulated power supply is the specified voltage ± 0.01 Vdc.
- 5) Check that the center of Siemens star chart meets the center of shot image screen with the zoom lens at TELE end and WIDE end respectively.

Specified voltage: The specified voltage varies according to the minipattern box, so adjustment the power supply output voltage to the specified voltage written on the sheet which is supplied with the minipattern box.

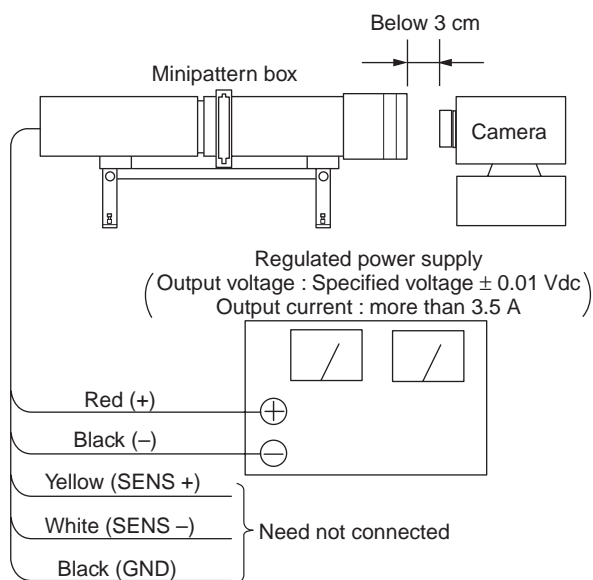

Fig. 6-1-21

Preparation of Flange Back Adj.

(Using the flange back adjustment jig)

(Luminance: about 300 lux)

Note 2: When using the flange back adjustment jig, take care of the following points:

- For the illumination, use a light source such as an incandescent lamp or inverter type fluorescent light free from flickering.
- Do not make an adjustment in the environment where fluorescent lamp flickering occurs even if the illuminance can be ensured with the room illumination only. Use an incandescent lamp or inverter type fluorescent light at a place free from the influence of room illumination.

- 1) Install the flange back adjustment jig so that the distance between it and the front of lens of camera is less than 3 cm.
- 2) Make the height of flange back adjustment jig and the camera equal.
- 3) Check that the center of chart meets the center of shot image screen with the zoom lens at TELE end and WIDE end respectively.

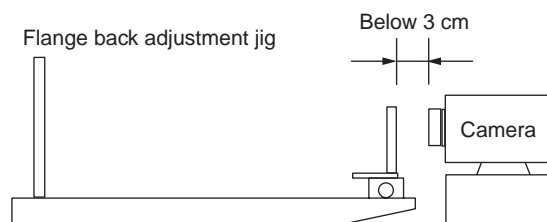

Fig. 6-1-22

[Adjusting method]

- 1) If the **[Start]** button of the CAMERA Adjustment 2 is clicked, the following message is displayed.
If "Wide Limit Adjustment" is necessary, click the **[Cancel]** button to interrupt the Adjustment Program, and perform "1. Wide Limit Adjustment".

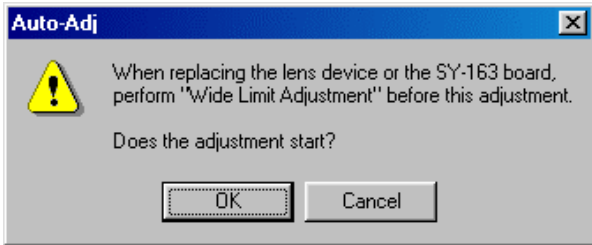

Fig. 6-1-23

- 2) If the **[OK]** button is clicked, the Automatic Adjustment Program executes "1. Data Setting during Camera Adj.".
- 3) Upon successful completion of the "1. Data Setting during Camera Adj.", the following message is displayed. Set the subject by referring to "Preparation of Flange Back Adj.".

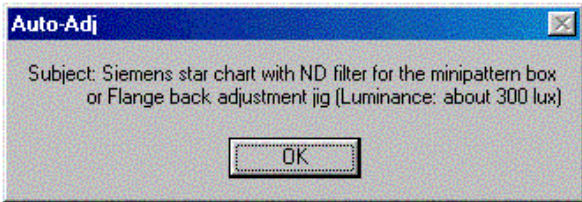

Fig. 6-1-24

- 4) If the **[OK]** button is clicked, "2. Flange Back Adj." and "3. Release of Data Setting during Camera Adj." will be executed.
- 5) Upon successful completion of all items of the CAMERA Adjustment 2, the following message is displayed. Click the **[OK]** button.

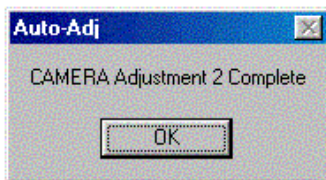

Fig. 6-1-25

4. CAMERA Adjustment 3

[Automatic Adjustment Program execution items and sequence]

1. Data Setting during Camera Adj.
2. Flange Back Check
3. Release of Data Setting during Camera Adj.

[Adjusting method]

- 1) Click the **[Start]** button of the CAMERA Adjustment 3.
- 2) The Automatic Adjustment Program executes "1. Data Setting during Camera Adj.".
- 3) Upon successful completion of the "1. Data Setting during Camera Adj.", the following message is displayed. Set the subject in accordance with the message.

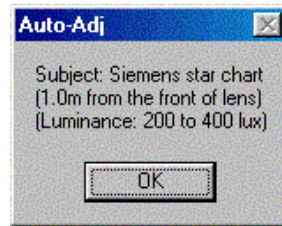

Fig. 6-1-26

- 4) Click the **[OK]** button is clicked, "2. Flange Back Check" is executed. The following messages are displayed, and then operate the camera to make a check in accordance with the messages.

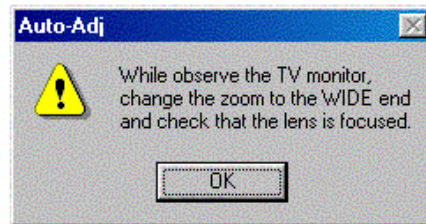

Fig. 6-1-27

- 5) Upon completion of "2. Flange Back Check", "3. Release of Data Setting during Camera Adj." is executed.
- 6) Upon successful completion of all items of the CAMERA Adjustment 3, the following message is displayed. Click the **[OK]** button.

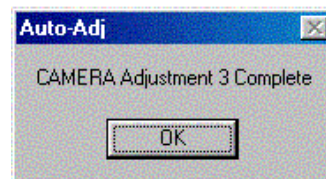

Fig. 6-1-28

5. Picture Frame Setting (Standard Picture Frame)

In the “CAMERA Adjustment 4”, “AWB 3200K-5800K Standard Data Input” and “CAMERA Adjustment 5”, set the picture frame so as to attain the positions shown in the following figure when shooting the 9 colors chart.

Check on the oscilloscope

Measurement Point: Video terminal of USB, A/V, DC IN cable for multi-use terminal (75Ω terminated)

1. Horizontal period

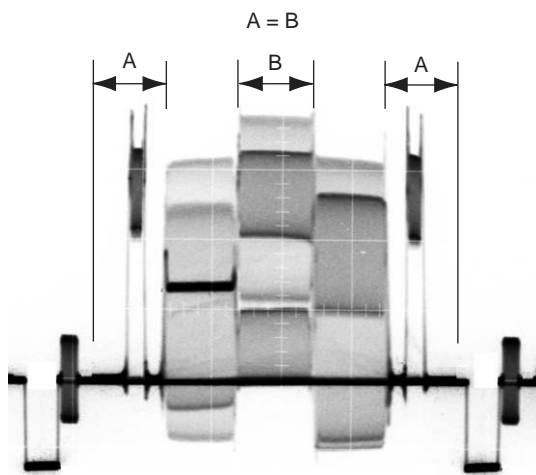

Fig. 6-1-29

2. Vertical period

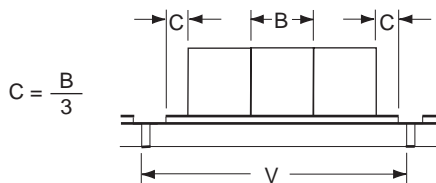

Fig. 6-1-30

Check on the monitor TV or the LCD screen

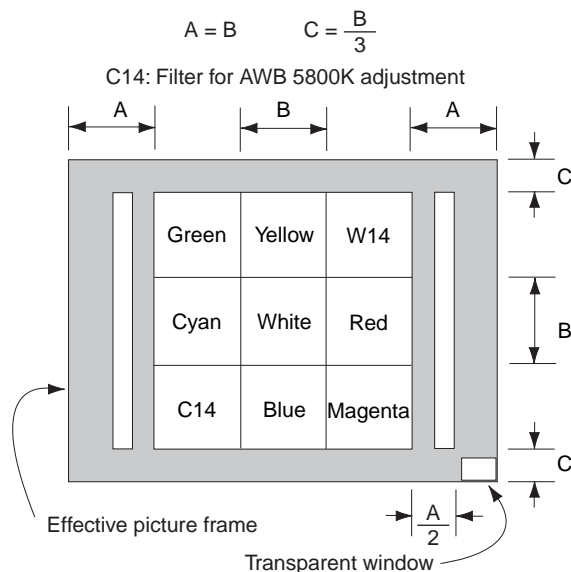

Fig. 6-1-31

6. CAMERA Adjustment 4

[Automatic Adjustment Program execution items and sequence]

1. Data Setting during Camera Adj.
2. Picture Frame Setting
3. F No. Compensation
4. Measure Gain Adj.
5. Mechanical Shutter Adj.
6. Light Value Adj.
7. Release of Data Setting during Camera Adj.

[Adjusting method]

- 1) Click the **[Start]** button of the CAMERA Adjustment 4.
- 2) The Automatic Adjustment Program executes the “1. Data Setting during Camera Adj.”.
- 3) Upon successful completion of “1. Data Setting during Camera Adj.”, “2. Picture Frame Setting” is executed. The following message is displayed, and then referring to Fig. 6-1-29 to Fig. 6-1-31, set the subject and click the **[OK]** button.

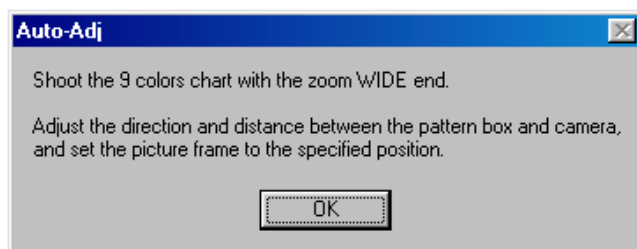

Fig. 6-1-32

After that, the next message is displayed. Then, change the chart in accordance with the message.

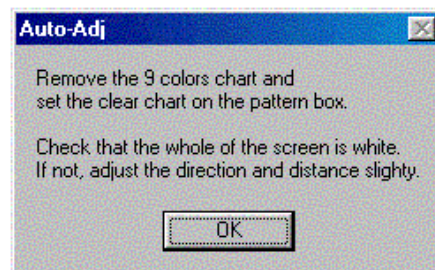

Fig. 6-1-33

- 4) Click the **[OK]** button, and the items from “3. F No. Compensation” to “7. Release of Data Setting during Camera Adj.” will be executed.
- 5) Upon successful completion of all items of the CAMERA Adjustment 4, the following message is displayed. Click the **[OK]** button.

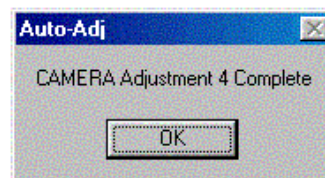

Fig. 6-1-34

7. AWB 3200K-5800K Standard Data Input

[Adjustment method]

- 1) Start the AWB Adjustment Program (T10AwbAdjustment.exe).
- 2) Click the **Connect** button to set the camera to the adjustment mode.

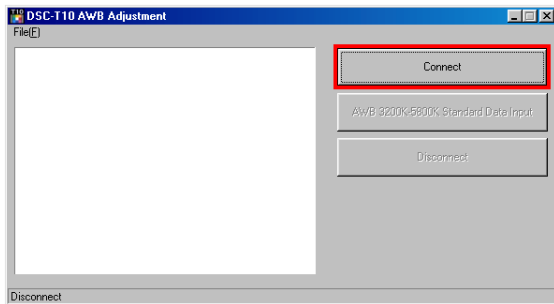

Fig. 6-1-35

- 3) Adjust the mode switch of the camera to “CAMERA” and set MACRO mode. Shoot the 9 colors chart with the zoom at WIDE end.
- 4) Adjust the camera direction and distance to set the picture frame. (Refer to 5. Picture Frame Setting)
- 5) Click the **AWB 3200K-5800K Standard Data Input** button.

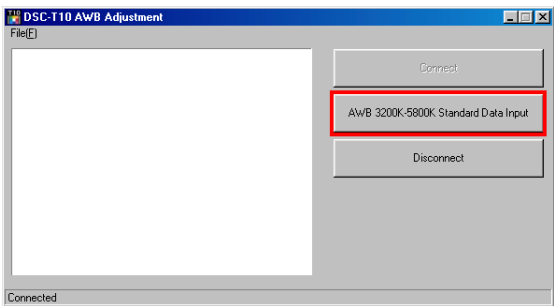

Fig. 6-1-36

- 6) A picture captured by the camera is displayed on the screen, and the adjustment and checking are performed.

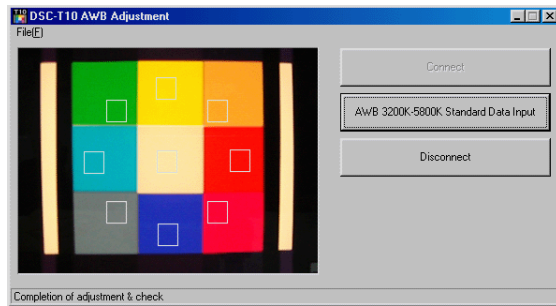

Fig. 6-1-37

Note: If the following message is displayed, the picture frame setting is faulty. Check the picture frame, and then perform readjustment.

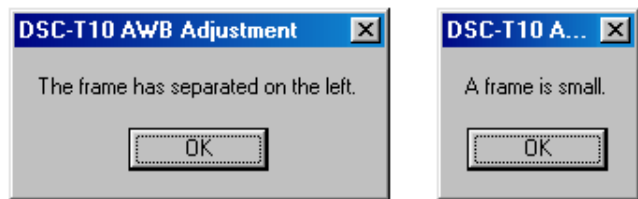

Fig. 6-1-38

- 7) Upon successful completion of the adjustment, the following message is displayed. Click the **OK** button.

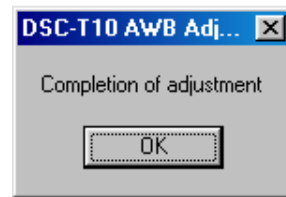

Fig. 6-1-39

- 8) Perform the “Camera Adjustment 5” successively without turning off the power switch of the camera.

8. CAMERA Adjustment 5

Note: After executing the “AWB 3200-5800K Standard Data Input” perform the “CAMERA Adjustment 5” successively without turning off the power switch of the camera.

[Automatic Adjustment Program execution items and sequence]

1. Data Setting during Camera Adj.
2. Picture Frame Setting
3. Color Reproduction Adj. & Check
4. CCD Linearity Check
5. CCD White Defect Compensation Check
6. CCD Black Defect Compensation Check
7. Release of Data Setting during Camera Adj.

[Adjusting method]

- 1) Click the **[Start]** button of the CAMERA Adjustment 5.
- 2) The Automatic Adjustment Program executes the “1. Data Setting during Camera Adj.”.
- 3) Upon successful completion of “1. Data Setting during Camera Adj.”, “2. Picture Frame Setting” is executed. The following message is displayed, and then referring to Fig. 6-1-29 to Fig. 6-1-31 (See page 6-21), set the subject and click the **[OK]** button.

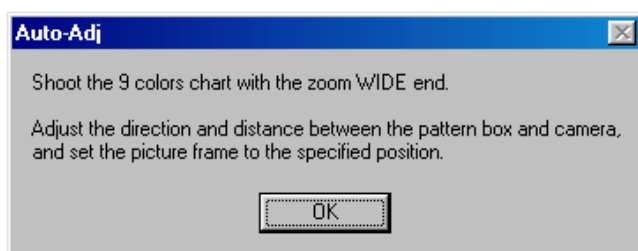

Fig. 6-1-40

- 4) After that, “3. Color Reproduction Adj. & Check” will be executed. Upon completion of adjustment, the check result is displayed on the Color Reproduction Check screen.

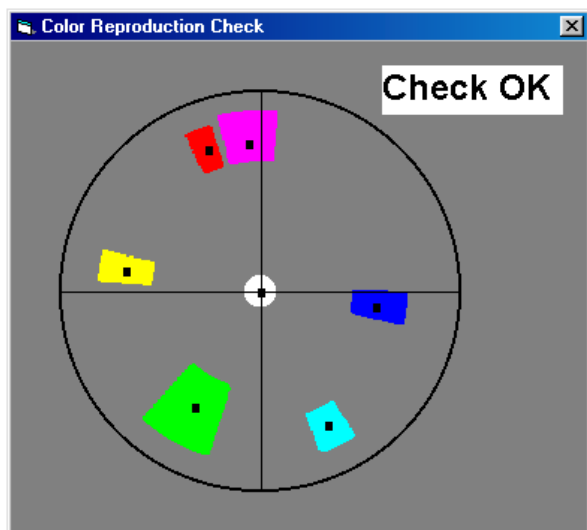

Fig. 6-1-41

At this time, the following message is displayed, and click the **[Yes]** button if the check result display at the upper right of Color Reproduction Check screen is OK, or the **[No]** button if NG.

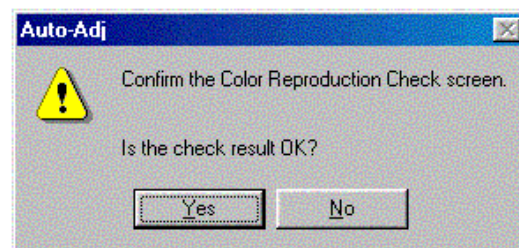

Fig. 6-1-42

- 5) Upon successful completion of “3. Color Reproduction Adj. & Check”, the following message is displayed. Change the chart in accordance with the message.

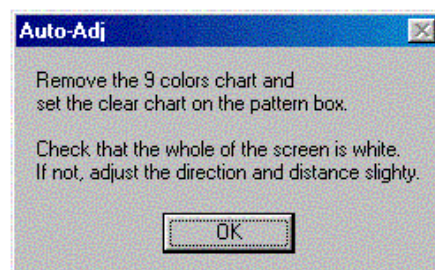

Fig. 6-1-43

- 6) Click the **[OK]** button, and the items from “4. CCD Linearity Check” to “7. Release of Data Setting during Camera Adj.” will be executed.
- 7) Upon successful completion of all items of the CAMERA Adjustment 5, the following message is displayed. Click the **[OK]** button.

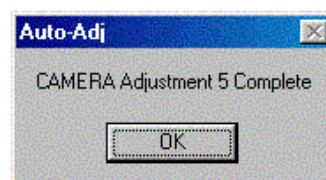

Fig. 6-1-44

9. CAMERA Adjustment 6

Note: “CAMERA Adjustment 6” is available only once after the power is turned on. If the adjustment is retried, turn off the power and turn on again.

[Automatic Adjustment Program execution items and sequence]

1. Data Setting during Camera Adj.
2. Strobe Adj.
3. Release of Data Setting during Camera Adj.

[Adjusting method]

- 1) Click the **[Start]** button of CAMERA Adjustment 6.
- 2) The Automatic Adjustment Program executes the “1. Data Setting during Camera Adj.”
- 3) Upon successful completion of the “1. Data Setting during Camera Adj.”, the following message is displayed. Set the subject in accordance with the message.
(For the Flash adjustment box, refer to “3. Preparing the Flash Adjustment Box” (see page 6-9).)

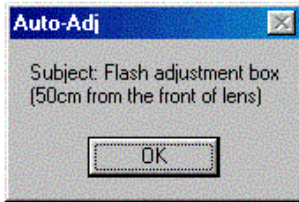

Fig. 6-1-45

- 4) Press the **[OK]** button, and the “2. Strobe Adj.” will be executed.
- 5) During execution of “2. Strobe Adj.”, the following message is displayed. After checking the flashing of strobe light, click the **[OK]** button. (This message is displayed 2 times during execution of adjustment.)

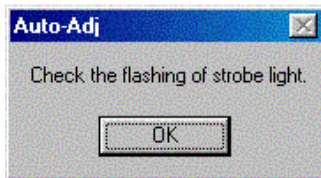

Fig. 6-1-46

- 6) Upon successful completion of “2. Strobe Adj.”, “3. Release of Data Setting during CAMERA Adj.” is executed.
- 7) Upon successful completion of all items of the CAMERA Adjustment 6, the following message is displayed. Click the **[OK]** button.

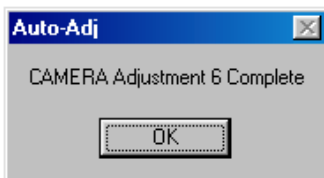

Fig. 6-1-47

10. CAMERA Adjustment 7

[Automatic Adjustment Program execution items and sequence]

1. Data Setting during Camera Adj.
2. Auto Focus Illumination Check
3. Release of Data Setting during Camera Adj.

[Adjusting method]

- 1) Click the **[Start]** button of CAMERA Adjustment 7.
- 2) The Automatic Adjustment Program executes the “1. Data Setting during Camera Adj.”
- 3) Upon successful completion of the “1. Data Setting during Camera Adj.”, the following message is displayed. Set the subject in accordance with the message.
(For the Flash adjustment box, refer to “3. Preparing the Flash Adjustment Box” (see page 6-9).)

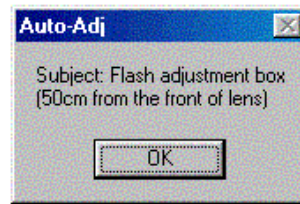

Fig. 6-1-48

- 4) Press the **[OK]** button, and the “2. Auto Focus Illumination check” will be executed.
- 5) Upon successful completion of the “2. Auto Focus Illumination Check”, the “3. Release of Data Setting during Camera Adj.” will be executed successively.
- 6) Upon successful completion of all items of the CAMERA Adjustment 7, the following message is displayed. Click the **[OK]** button.

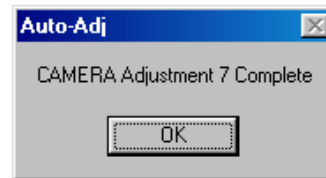

Fig. 6-1-49

11. CAMERA Adjustment 8

Perform this adjustment only when replacing the angular velocity sensor or lens block. When the microprocessor, circuit etc. is damaged, don't perform this adjustment but check the operations only.

11-1. Preparation when the angular velocity sensor or the SY-163 board is replaced

Note down the sensitivity displayed on the angular velocity sensor of the repair parts. At this time, note down also to which board it was attached to.

Be sure to check because if attached incorrectly, the screen will vibrate up and down or left and right during the steady shot operations.

Precautions on the Parts Replacement

The PITCH sensor and the YAW sensor are different parts.

Precautions on Angular Velocity Sensor

The sensor incorporates a precision oscillator. Handle it with care as if it dropped, the balance of oscillator will be disrupted and operations will not be performed properly.

Adjustment Page	CF
Adjustment Address	0C, 0D

Note 1: The sensor sensitivity of SE501 and SE502 of the SY-163 board is written only repair parts.

Preparation:

- 1) Read the PITCH sensor (SY-163 board SE501) sensitivity written on repair parts, and named this as S_{501} .
- 2) Read the YAW sensor (SY-163 board SE502) sensitivity written on repair parts, and named this as S_{502} .

SY-163 BOARD (SIDE B)

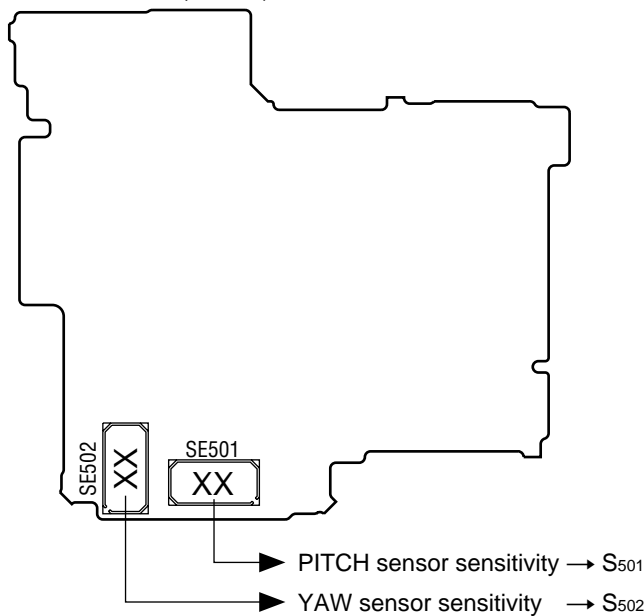

Fig. 6-1-50

11-2. Preparation when the lens is replaced

Note down the PITCH/YAW data on the replacement lens for repair.

Adjustment Page	CF
Adjustment Address	0C, 0D

Note 1: The PITCH/YAW data of lens is written only repair parts.

Preparation:

- 1) Read the PITCH data written on repair parts, and named this as L_1 .
- 2) Read the YAW data written on repair parts, and named this as L_2 .

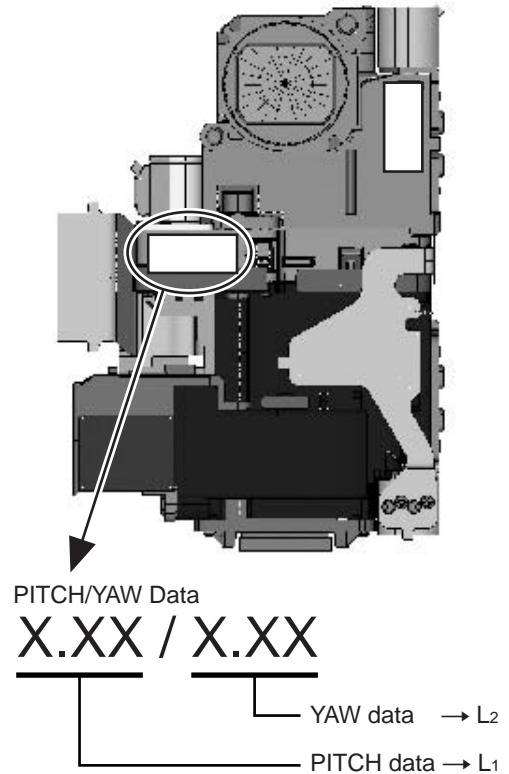

Fig. 6-1-51

11-3. Angular Velocity Sensor Sensitivity Adjustment

[Adjusting method]

- 1) Click the **[Start]** button of Camera Adjustment 8, and the following screen will appear.

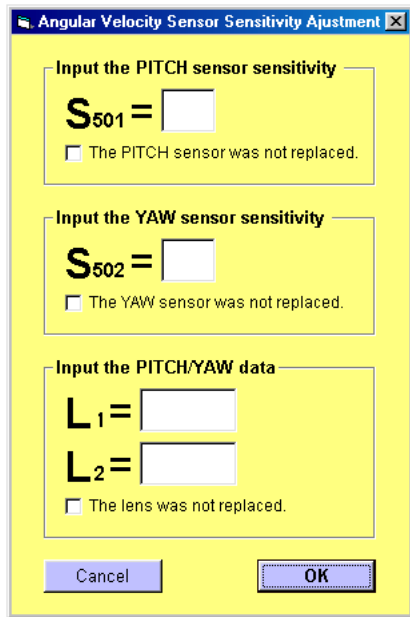

Fig. 6-1-52

- 2) Input the sensitivity of respective sensors (S_{501} , S_{502}) read at "Preparation" into the screen.
If only either sensor was replaced, give a check to the checkbox for the sensor not replaced at the lower left of the screen.
- 3) Input the PITCH/YAW data of lens (L_1 , L_2) read at "Preparation" into the screen.
If the lens was not replaced, give a check to the checkbox at the lower left of the screen.
- 4) Click the **[OK]** button, and the adjustment data is then calculated from the sensor sensitivity value and the calculation result is written to the memory in the camera.
- 5) Upon successful completion of the data writing, the following screen will appear. Check that the steady shot function operates normally.

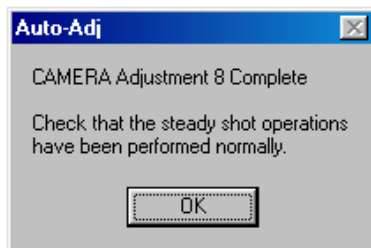

Fig. 6-1-53

1-5. LCD SYSTEM ADJUSTMENTS

1-5-1. Function of Each Button on LCD System Adjustment Screen

Click the **LCD SYSTEM ADJUSTMENT** button on the Main Menu screen, and the “LCD SYSTEM ADJUSTMENT” screen in Fig. 6-1-54 will appear.

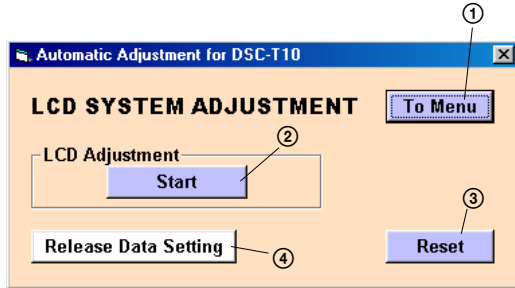

Fig. 6-1-54

- ① **To Menu** button
The Main Menu screen comes back.
- ② **Start** button
“LCD Adjustment” starts.
- ③ **Reset** button
This button functions same as the “Initialize” of the setup screen.
- ④ **Release Data Setting** button
The data setting at the adjustment is cancelled.
During the data setting, the button color changes from “white” to “red”. When the data setting is cancelled, the button color returns to “white”.
(Use this button when an error occurred in the LCD adjustment. If the adjustment completed successfully, the data setting is automatically cancelled and the button color returns to “white”.)

1-5-2. Adjustment Items of LCD System Adjustment
The adjustment items of LCD system adjustment are as listed in Table 6-1-4. The Automatic Adjustment Program executes the adjustment items if the LCD Adjustment Start button is clicked.

Button Name	Adjustment	Signal	Page	Address
LCD Adjustment	V-COM adj.	Arbitrary	8F	11
	White Balance adj.		8F	42, 43, 58, 59

Table 6-1-4

1-5-3. Adjusting Method

[Automatic Adjustment Program execution items and sequence]

1. Data Setting during LCD Adj.
2. V-COM Adj.
3. White Balance Adj.
4. Release of Data Setting during LCD Adj.

[Adjusting method]

- 1) Click the **[Start]** button of the LCD Adjustment.
- 2) The Automatic Adjustment Program executes "1. Data Setting during LCD Adj."
- 3) Upon successful completion of the "1. Data Setting during LCD Adj.", the following message is displayed during execution in "2. V-COM Adj.". On the SEUS operation screen, operate the UP/DOWN key so that the brightness of portions A and B on the LCD panel is equal. After the adjustment, click the **[OK]** button.

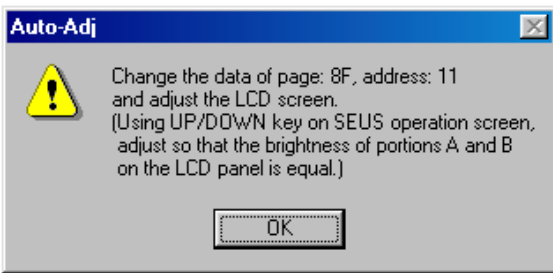

Fig. 6-1-55

- 4) Upon completion of "2. V-COM Adj.", the following screen is displayed during the execution of "3. White Balance Adj.". Check that the LCD screen is not colored. If colored, using the **[Up]**/**[Down]** button on the screen, adjust so that the LCD screen is not colored. After the adjustment, click the **[End]** button in the screen.

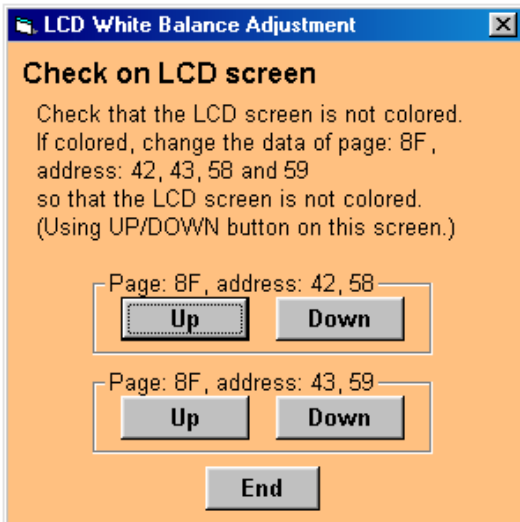

Fig. 6-1-56

- 5) If the **[End]** button is clicked, "4. Release of Data Setting during LCD Adj." will be executed.

- 6) Upon successful completion of all item the LCD Adjustment, the following message is displayed. Click the **[OK]** button.



Fig. 6-1-57

SEUS operation screen

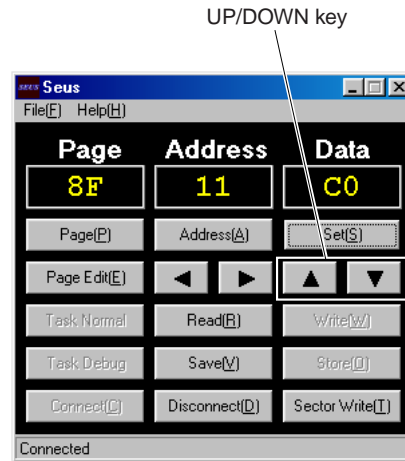

Fig. 6-1-58

Check on the LCD screen (V-COM Adj.)

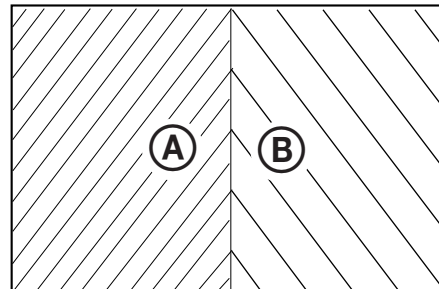

Fig. 6-1-59

1-6. ERROR

In case of an error during the execution of adjustment, the Automatic Adjustment Program interrupts the processing at that point, and displays an error message, and then terminates the program execution there.

1-6-1. Error Message

When an error message is displayed, perform the remedy given below, and then retry adjustment. If the error message is displayed though the remedy was performed, the circuits will be faulty.

1. Connect Error

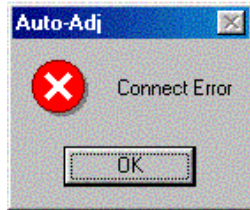

Fig. 6-1-60

Symptom	USB communication with the set is abnormal.
Cause	<ul style="list-style-type: none"> • USB cable is not inserted tightly. • Power supply is not installed correctly. • Communication with SEUS is abnormal.
Remedy	<ul style="list-style-type: none"> • Disconnect the USB cable once, and then reconnect it tightly and check that the set is in "USB Mode". • Install the power supply correctly. • Start the SEUS and click the Connect to check that the connection state is established.

2. RESET the CAMERA and Try Again

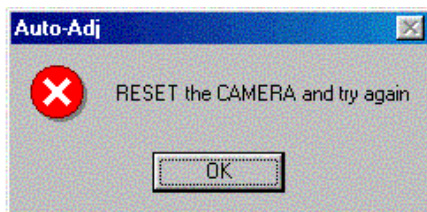
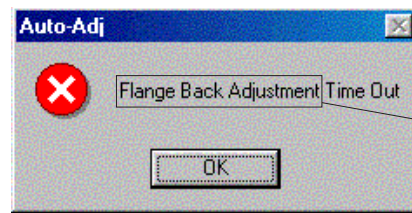

Fig. 6-1-61

Symptom	The camera is not ready for adjustment.
Cause	<ul style="list-style-type: none"> • Data error exists in the camera.
Remedy	<ul style="list-style-type: none"> • Reset the camera.

3. Adjustment Time Out



This part indicates the adjustment item in which an error occurred.

Fig. 6-1-62

Symptom	Adjustment does not finish within the specified time.
Cause	<ul style="list-style-type: none"> • Adjustment conditions are wrong. • Data error exists in the camera.
Remedy	<ul style="list-style-type: none"> • Check that the conditions such as a subject are correct. • Reset the camera.

4. Adjustment NG

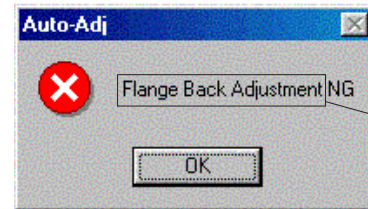

This part indicates the adjustment item in which an error occurred.

Fig. 6-1-63

Symptom	The adjusted data does not become the specified value.
Cause	<ul style="list-style-type: none"> • Adjustment conditions are wrong. • Data error exists in the camera.
Remedy	<ul style="list-style-type: none"> • Check that the conditions such as a subject are correct. • Reset the camera.

5. Data Save Error

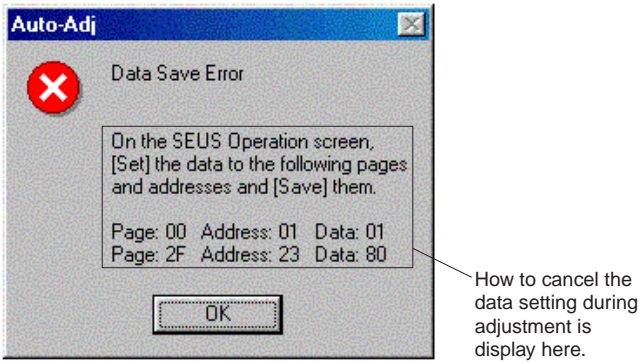

Fig. 6-1-64

Symptom	data cannot be saved normally. (The data setting during adjustment cannot be cancelled)
Cause	<ul style="list-style-type: none"> • Data writing to the flash memory failed. • Connection is faulty. • Power supply is not installed correctly.
Remedy	<ul style="list-style-type: none"> • On the SEUS Operation screen, [Set] the data to the pages and addresses displayed in the message, and [Save] them. (Cancel manually the data setting during adjustment.) • Check the connection. • Install the power supply correctly.

1-6-2. Precautions When an Error Occurred

The Automatic Adjustment Program sets the data for adjustment before the adjustment starts. Accordingly, if the adjustment terminates by an error, the data during the adjustment may be left in the camera.

Note 1: With this data left in the camera, the camera will not operate normally.

In this case, the **Release Data Setting** button is displayed in “red” on the screen as shown in Fig. 6-1-65, 66 and 67. Click the **Release Data Setting** button to cancel the data setting. When the data setting is cancelled, the button color becomes “white”.

Note 2: When “Data Save Error” occurred, the **Release Data Setting** button is displayed in “white”.

To cancel the data setting, perform it on the SEUS Operation screen. How to cancel the data setting is displayed in the error message.

Video System Adjustment screen

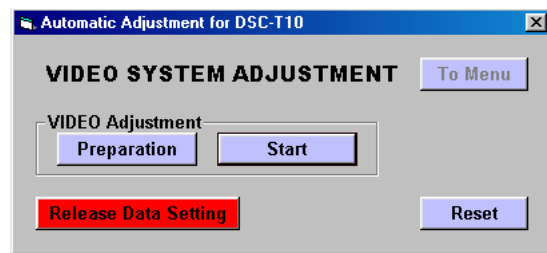

Fig. 6-1-65

Camera System Adjustment screen

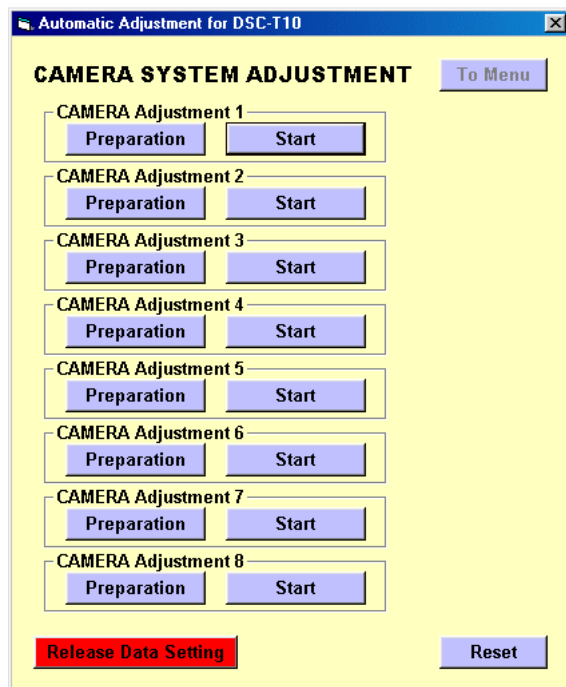

Fig. 6-1-66

LCD System Adjustment screen

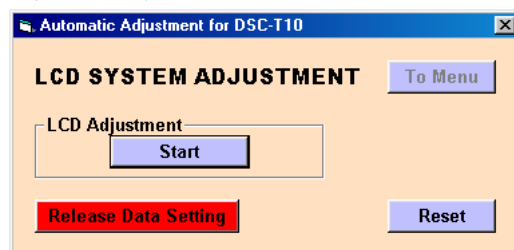

Fig. 6-1-67

1-7. INITIALIZATION OF DATA

1. Initializing All Page Data

By performing the following procedure, data of all pages will be initialized.

Note: If all page data have been initialized, all adjustments need to be performed again.

Initializing Method:

- 1) Select page: 00, address: 01 and set data: 01.
- 2) Click **[Sector Write]** on the SEUS screen to display the SEUS SECTOR WRITE screen.
- 3) Check that the SET ID is "0E".
- 4) Click **[All]** of the ALL SELECT buttons to select all pages. (Fig. 6-1-68 **(A)**)
- 5) Click **[Write]** to write the initializing data to the flash memory of the camera.
- 6) Wait for 3 sec.
- 7) Click **[Close]** to close the SEUS SECTOR WRITE screen.
- 8) Select page: 2F, address: 4E and set data: 47.
- 9) Select page: 40, address: 38 and set data: 00.
- 10) Click **[Save]** on the SEUS screen.
- 11) Select page: 80, address: 34, and check that the data is "00".
- 12) Select page: 80, address: 30, and check that the data is "00".
- 13) Perform "VIDEO OUT Default Data Check" and "Initial Language Data Check".

Processing after Completing Initializing

Order	Page	Address	Data	Procedure
1	40	28	01 [Set]	(Note)

Note: At this time, the camera is reset and the power is turns off once and then on again. Accordingly, the SEUS goes in "disconnect" state, but this is not a trouble. Click **[Connect]** on the SEUS screen to restore the "connected" state. (In case that the power does not turn on again, press the power button.)

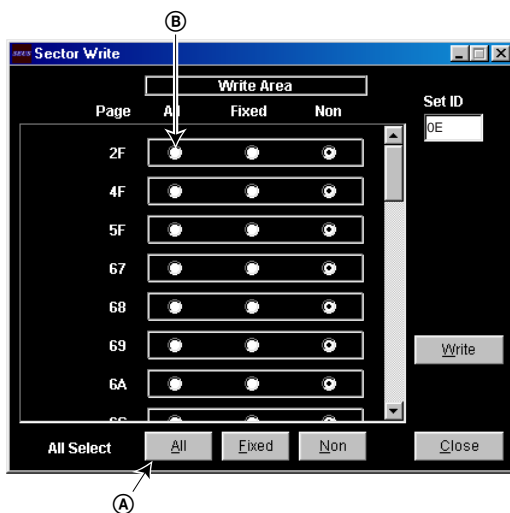

Fig. 6-1-68

2. Initializing Single Page Data

By performing the following procedure, data of the page that you want to initialize will be initialized.

Note 1: If the 6E or 6F or 78 or CE or CF page data have been initialized, the following adjustment needs to be performed again.

- 1) Camera system adjustments

Note 2: If the 8F page data have been initialized, the following adjustment needs to be performed again.

- 1) Video system adjustments
- 2) LCD system adjustments

Initializing Method:

- 1) Select page: 00, address: 01 and set data: 01.
- 2) Click **[Sector Write]** on the SEUS screen to display the SEUS SECTOR WRITE screen.
- 3) Check that the SET ID is "0E".
- 4) Click "All" of the option buttons of target page. (Fig. 6-1-68 **(B)**)
- 5) Click **[Write]** to write the initializing data to the flash memory of the camera.
- 6) Wait for 3 sec.
- 7) Click **[Close]** to close the SEUS SECTOR WRITE screen.
- 8) When 2F page is initialized, select page: 2F, address: 4E and set data: 47.
- 9) Select page: 40, address: 38 and set data: 00.
- 10) Click **[Save]** on the SEUS screen.
- 11) Select page: 80, address: 34, and check that the data is "00".
- 12) Select page: 80, address: 30, and check that the data is "00".
- 13) When 4F page is initialized, perform "VIDEO OUT Default Data Check" and "Initial Language Data Check".

Processing after Completing Initializing

Order	Page	Address	Data	Procedure
1	40	28	01 [Set]	(Note)

Note: At this time, the camera is reset and the power is turns off once and then on again. Accordingly, the SEUS goes in "disconnect" state, but this is not a trouble. Click **[Connect]** on the SEUS screen to restore the "connected" state. (In case that the power does not turn on again, press the power button.)

6-2. SERVICE MODE

1. Setting the Test Mode

Page 40	Address A1, A3
---------	----------------

- Forced CAMERA mode
 - 1) Select page: 40, address: A1, and set data: 01.
 - 2) Select page: 40, address: A3, and set data: 01.
- Forced MOVIE mode
 - 1) Select page: 40, address: A1, and set data: 01.
 - 2) Select page: 40, address: A3, and set data: 07.
- Forced PLAY mode
 - 1) Select page: 40, address: A1, and set data: 01.
 - 2) Select page: 40, address: A3, and set data: 08.
- After completing adjustments/repairs, release the data setting.
 - 1) Select page: 40, address: A1, and set data: 00.

2. Bit Value Discrimination

In the following items, the bit values must be discriminated from the data displayed on the SEUS. Whether bit values are “1” or “0” can be discriminated from the table shown below.

Data displayed on SEUS

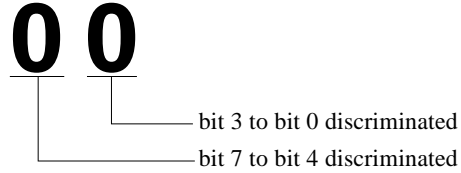

Display on the SEUS	Bit values			
	bit3 or bit7	bit2 or bit6	bit1 or bit5	bit0 or bit4
0	0	0	0	0
1	0	0	0	1
2	0	0	1	0
3	0	0	1	1
4	0	1	0	0
5	0	1	0	1
6	0	1	1	0
7	0	1	1	1
Ⓐ 8	1	0	0	0
9	1	0	0	1
A	1	0	1	0
B	1	0	1	1
C	1	1	0	0
D	1	1	0	1
Ⓑ E	1	1	1	0
F	1	1	1	1

Example: If the displayed data is “8E”, bit 7 - bit 4 values can be discriminated from block (A), and also bit 3 - bit 0 values from block (B).

3. LED Check

Page 80	Address 12
Page 8E	Address FE

Using method:

- 1) Select page: 00, address: 01, and set data: 01.
- 2) Select page: 8E, address: FE, and set data: 20.
- 3) Select page: 80, address: 12, and set data: 01.
- 4) Check that all LED are lit.
 - SELF TIMER/AF ILLUMINATOR
 - MS ACCESS
- 5) Select page: 80, address: 12, and set data: 00.
- 6) Select page: 8E, address: FE, and set data: 00.
- 7) Select page: 00, address: 01, and set data: 00.
- 8) Click Disconnect on the SEUS screen.
- 9) Disconnect the USB cable.
- 10) Turn off the power.

4. Switch Check (1)

Page 80	Address 13
---------	------------

Function	When data = 00	When data = 01	When data = 02
Shutter button (XAE LOCK SW) (CONTROL SWITCH BLOCK (RL60530) S004)	OFF	ON	ON
Shutter button (XSHUTTER SW) (CONTROL SWITCH BLOCK (RL60530) S004)	OFF	OFF	ON

Using method:

- 1) Select page: 80, address: 13.
- 2) By discriminating the read data, the state of the switches can be discriminated.

5. Switch Check (2)

Page 40	Address 5A
---------	------------

Function	When data = FF or 00	When data = 55
Steady shot button (CONTROL SWITCH BLOCK (RL60530) S003)	OFF	ON

Using method:

- 1) Select page: 40, address: 5A.
- 2) By discriminating the read data, the state of the switches can be discriminated.

6. Switch Check (3)

Page 20	Addresses A0, A1
---------	------------------

Using method:

- 1) Select page: 20, addresses: A0 and A1.
- 2) By discriminating the read data, the pressed key can be discriminated.

Address	Data						
	00 to 0F	22 to 3C	42 to 5C	6E to 88	9C to B5	C1 to DB	FF
A0 (KEY AD0) (IC301 AA13)	CONTROL UP (SW51800 block) (S001)	CONTROL RIGHT (SW51800 block) (S002)	CONTROL DOWN (SW51800 block) (S003)	CONTROL LEFT (SW51800 block) (S004)	CONTROL SET (SW51800 block) (S006)	-	No key input
A1 (KEY AD1) (IC301 W15)	ZOOM T (SW51800 block) (S005)	ZOOM W (SW51800 block) (S007)	SCREEN DISPLAY ON/OFF (SW51800 block) (S008)	MENU (SW51800 block) (S009)	IMAGE SIZE/ DELETE (SW51800 block) (S010)	SLIDE SHOW (SW51800 block) (S011)	No key input

7. Mode Switch Check

Page 20	Addresses A3
---------	--------------

Using method:

- 1) Select page: 20, addresses: A3.
- 2) By discriminating the read data, the state of the mode switch can be discriminated.

Address	Data		
	2B to 33	49 to 54	60 to 6C
A3 (MODE DIAL0) (IC301 AB14)	MOVIE (BT-029 flexible) (S005)	PLAY (BT-029 flexible) (S005)	CAMERA (BT-029 flexible) (S005)

8. Self Diagnosis Code

Display Code	Countermeasure	Cause	Caution Display During Error
C:32:□□	Turn the power off and on again.	Trouble with hardware.	SYSTEM ERROR
C:13:□□	Format the "Memory Stick" or internal memory.	"Memory Stick" or internal memory is unformatted.	FORMAT ERROR
	Insert a new "Memory Stick".	"Memory Stick" is broken.	MEMORY STICK ERROR
	Turn the power off and on again.	Trouble with internal memory.	INTERNAL MEMORY ERROR
E:61:□□	Checking of lens drive circuit.	When failed in the focus zoom initialization.	-
E:62:□□	Inspect angular velocity sensor peripheral circuits.	Steady shot function does not work well.	
E:91:□□	Checking of flash unit or replacement of flash unit. (Note)	Abnormality when flash is being charged.	

Note: After repair, be sure to execute the "Initialize" of the setup screen.

DSC-T10

SONY®

Auto-ADJ

SERVICE MANUAL

Ver. 1.1 2007.08



SUPPLEMENT-1

File this supplement with the service manual.
(DI07-045)

- Change of Automatic Adjustment Program
- Addition of “DESTINATION DATA WRITE”
- Addition of “How to read the sensitivity data of angular velocity sensor.”

• Precaution on Replacing the SY-163 Board

- Change of Automatic Adjustment Program
Version of Automatic Adjustment Program has been changed from Ver_1.0r01 into Ver_1.1r02.

-  : Points changed portion.
-  : Points added portion.
-  : Points deleted portion.

6-1. CAMERA SECTION ADJUSTMENTS

1-2. ADJUSTMENT PROGRAMS

1-2-1. Automatic Adjustment Program (Service manual page 6-11)

2. Start of Automatic Adjustment Program

Double-click the application file (DSC-T10 Auto-Adj Ver_1.1r02.exe), and the Automatic Adjustment Program will start.

Note:  (numeric value) of the file name varies depending on the version of Automatic Adjustment Program.

3. Function of Each Button on Main Menu Screen

When the Automatic Adjustment Program started, the Main Menu screen in Fig. 6-1-10 will appear. On this screen, select each adjustment section.

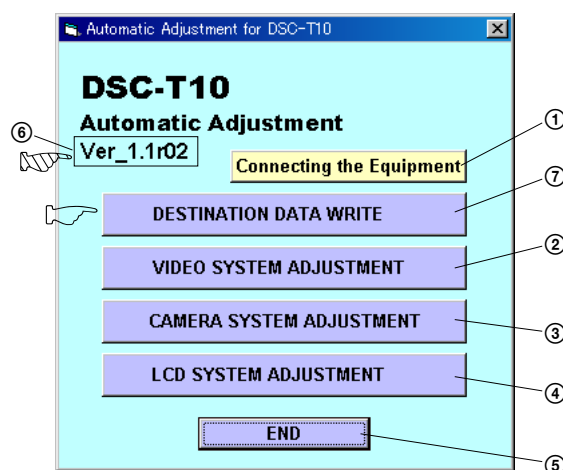



Fig. 6-1-10

- ⑥ This part indicates the version of Automatic Adjustment Program.

- ⑦  **DESTINATION DATA WRITE** button
The “DESTINATION DATA WRITE” screen appears.

• Addition of “DESTINATION DATA WRITE”

Precaution on Replacing the SY-163 Board

At first, execute “DESTINATION DATA WRITE” when the SY-163 board was replaced.

By executing this processing, “VIDEO OUT Default Data Check” and “INITIAL LANGUAGE Default Data Check” on page 6-1 and page 6-2 of the Service Manual is no longer necessary.

DESTINATION DATA WRITE

If this processing is executed, the SY-163 board is set to the factory default setting according to the specified destination.

Setting items:

- Font data for camera display
- Initial setting of display language
- VIDEO OUT Default Data

1. Function of Each Button on Destination Data Write Screen

Click the [DESTINATION DATA WRITE] button on the Main Menu screen, and the “DESTINATION DATA WRITE” screen in following figure will appear.

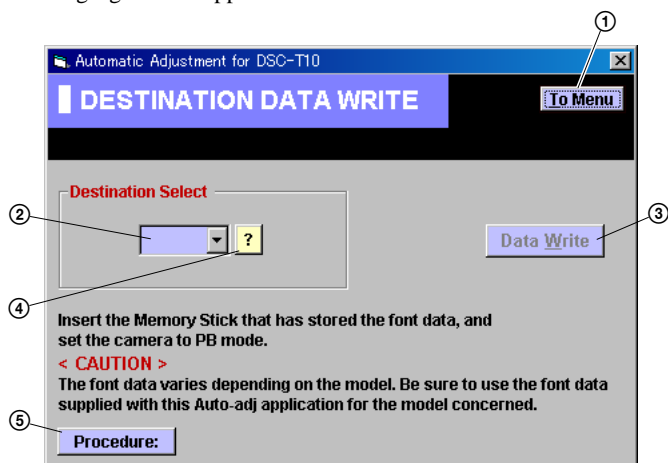

- 1 [To Menu] button
Return to the main menu.
- 2 Destination List
Select the written destination
- 3 [Data Write] button
Write the destination data to the camera.
- 4 [?] button
Indicate the destination table.
- 5 [Procedure] button
Indicate the procedure.

2. Destination Data Write

[Writing method]

- 1) Prepare a Memory Stick formatted by a camera.
- 2) Copy all of the font data CX_FONT1.ash to CX_FONT4.ash supplied with this program to the root directory of the Memory Stick.
- 3) Insert the Memory Stick in the set.
- 4) Select the target destination from the pulldown list.

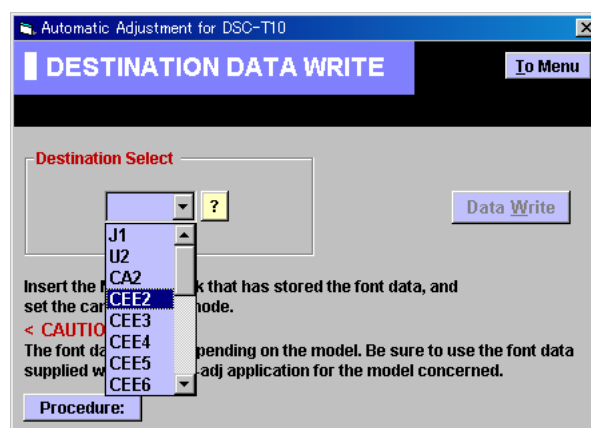

- 5) Click the [Data Write] button.

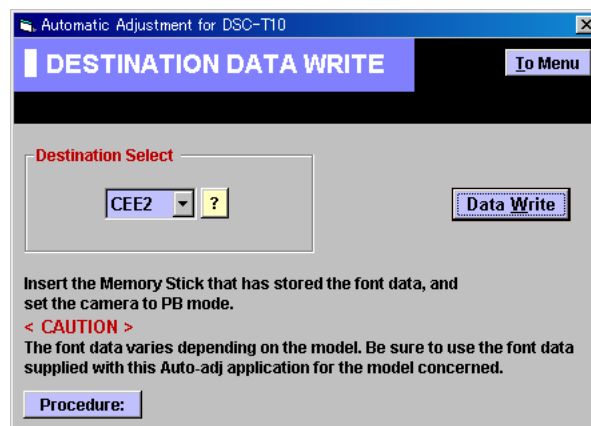

- 6) When the “Set the camera to PB mode” message is appeared, confirm that the camera mode is PB. Then click the [OK] button to continue the processing.
- 7) Following message will be appeared after completing data writing.



- 8) Remove the Memory Stick from the set and disconnect the USB cable.
- 9) Execute the Initialize operation using the Setup screen.

LANGUAGE GP	DESTINATION	AREA	SELECTABLE LANGUAGE																	VIDEO OUT Default					
			Japanese	English	French	German	Spanish	Italian	Portuguese	Simplified Chinese	Traditional Chinese	Arabic	Dutch	Russian	Swedish	Korean	Norwegian	Danish	Finnish		Polish	Hungarian	Czech	Persian	Thai
GP1	J1	J	●																					NTSC	
GP2	U2	US		●	○			○	○															NTSC	
	CA2	CND		●	○			○	○															NTSC	
	AU2	AUS		●	○			○	○															PAL	
GP3	CEE2	AEP		○	○	○	○	○	○															PAL	
	CEE3			●	○			○	○																PAL
	CEE4			○	○	○	○	○	○																PAL
	CEE5			●	○	○	○	○	○																PAL
	CEE6			●	○	○	○	○	○																PAL
	CEE7			●	○	○	○	○	○																PAL
	CEH		UK		●	○			○	○															PAL
GP4	E15	E		●				○	○															PAL	
	E32			●				○	○															PAL	
	E33			○			●		○	○														NTSC	
	AR2	AR		○			●		○	○														NTSC	
	BR1	BR		○					○	○														NTSC	
	HK1	HK		●				○	○															PAL	
	CN2	CH		○					○	○														PAL	
	KR2	KR		○					○	○														NTSC	
	JE3	JE		●				○	○					○										PAL	

• Addition of “How to read the sensitivity data of angular velocity sensor”

- : Points added portion.
- : Points changed portion.

1-4. CAMERA SYSTEM ADJUSTMENTS

1-4-3. Adjusting Method

11. CAMERA Adjustment 8

11-1. Preparation when the angular velocity sensor or the SY-163 board is replaced

(Service manual page 6-25)

Preparation:

- 1) Read the PITCH sensor (SY-163 board SE501) sensitivity written on repair parts, and named this as S₅₀₁.
- 2) Read the YAW sensor (SY-163 board SE502) sensitivity written on repair parts, and named this as S₅₀₂.

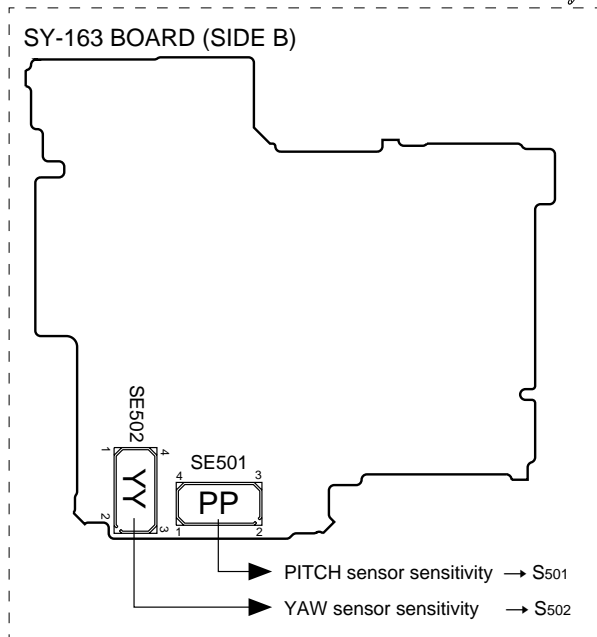

Fig. 6-1-50

How to read the sensitivity data of angular velocity sensor

With the pins 1 and 2 of angular velocity sensor placed in the lower position, read the data value.

Description example :

For the sensor sensitivity value 60

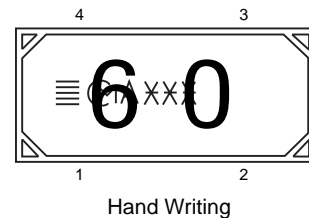

Revision History

Ver.	Date	History	Contents	S.M. Rev. issued
1.0	2006.07	Official Release	—	—
1.1	2007.08	Supplement-1 (S1 DI07-045)	<ul style="list-style-type: none">• Change of Automatic Adjustment Program Version of Automatic Adjustment Program has been changed from Ver_1.0r01 into Ver_1.1r02.• Addition of “DESTINATION DATA WRITE”• Addition of “How to read the sensitivity data of angular velocity sensor”	Yes